



**bticino**

**NİSAN 2026  
FİYAT LİSTESİ**

Bir grup markasıdır

**legrand®**

# LIVING now®



## Zamansız tasarım, akıllı çözümler

Living ailesinin en yeni üyesi olan Living Now, zamansız tasarımının yanı sıra sunduğu akıllı çözümler ile sektörde bir devrime öncülük ediyor. Evinizi, e-mail hesabınızı ya da banka hesaplarınızı kontrol eder gibi kontrol edin. Tüm bu kontroller tamamen güvenli ve kolay kullanımı ile parmağınızın ucunda.



Geleneksel  
kontrol



Akıllı telefonla  
kontrol



Sesli kontrol

[livingnow.bticino.com.tr](http://livingnow.bticino.com.tr)

**bticino**

TÜM İHTİYAÇLAR İÇİN DOĞRU ÇÖZÜM

# AKILLI ELEKTRİK SİSTEMİ

Living Now <sup>WITH</sup> Netatmo



HOME + CONTROL

## GELENEKSEL KURULUM

Geleneksel bir elektrik tesisatı kurun ve akıllı işlevleri ekleyin.  
HOME+CONTROL uygulamasını kullanarak kontrol edin.

## FONKSİYONLAR

- Aydınlatma
- Perde/panjur
- Prizler
- Sıcaklık kontrolü
- Senaryo kontrolü
- Tüketim detayı görüntüleme
- Bildirimler alabilme
- Planlanabilir programlar

## NASIL KONTROL ETMEK İSTERSEN

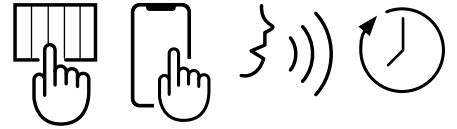

## Light Now

Anahtarlar	6
Diğer Anahtarlar	7
Prizler	8
TV Prizleri	9
Data ve Telefon Prizleri	9
Elektronik Prizler	10
Audio Video Prizler	10
Dimmerler	10
Hareket Sensörleri	11
Termostatlar	11
Otel Çözümleri	11
İkaz ve Sinyal Lambaları	11
Tuş Kapakları	12
Boşluk Kapakları	14
Kaideler	14
Plastik Çerçeveler	15

## Livinglight

Anahtarlar	42
Diğer Anahtarlar	43
Prizler	44
TV Prizleri	45
Data ve Telefon Prizleri	45
Elektronik Prizler	46
Audio Video Prizler	46
Dimmerler	46
Hareket Sensörleri	47
Termostatlar	47
Otel Çözümleri	47
İkaz ve Sinyal Lambaları	48
LED Lambalar	49
Boşluk Kapakları	49
Tuş Kapakları	50
Kaideler	52
Polimer Plastik Çerçeveler	53
Metal Çerçeveler	54
Living International Çerçeveler	54
AIR Çerçeveler	55

## Living Now

Anahtarlar	20
Diğer Anahtarlar	21
Prizler	24
TV Prizleri	27
Data ve Telefon Prizleri	28
Elektronik Prizler	29
Audio Video Prizler	29
Dimmerler	30
Termostatlar	30
Hareket Sensörleri	31
Otel Çözümleri	32
İkaz ve Sinyal Lambaları	33
LED Lambalar	34
Boşluk Kapakları	34
Tuş Kapakları	35
Kaideler	36
Polimer Plastik Çerçeveler	37
Metal Çerçeveler	38
Ahşap Çerçeveler	38

## Light Now with Netatmo

Bağlı Aydınlatma Kontrol Cihazları	56
Kablosuz Aydınlatma Kontrol Cihazları	56
Bağlı Perde/Panjur Kontrol Cihazları	57
Kablosuz Perde/Panjur Kontrol Cihazları	57
Bağlı Enerji Yönetim Cihazları	57
Bağlı Termostatlar	58
Ağ Geçidi Modülleri	58
Kablosuz Senaryo Kontrol Cihazları	59

## Living Now with Netatmo

Bağlı Aydınlatma Kontrol Cihazları	62
Kablosuz Aydınlatma Kontrol Cihazları	63
Bağlı Perde/Panjur Kontrol Cihazları	64
Kablosuz Perde/Panjur Kontrol Cihazları	65
Bağlı Enerji Yönetim Cihazları	66
Prizli Ağ Geçidi Modülü	67
Ağ Geçidi Modülleri	68
Bağlı Termostatlar	68
Kablosuz Senaryo Kontrol Cihazları	69

## LivingLight with Netatmo

Baęlı Aydınlatma Kontrol Cihazları	70
Kablosuz Aydınlatma Kontrol Cihazları	70
Baęlı Perde/Panjur Kontrol Cihazları	71
Kablosuz Perde/Panjur Kontrol Cihazları	71
Baęlı Enerji Yönetim Cihazları	71
Baęlı Termostatlar	72
Aę Geçidi Modülleri	72
Kablosuz Senaryo Kontrol Cihazları	72

## Classia with Netatmo

Baęlı Aydınlatma Kontrol Cihazları	74
Kablosuz Aydınlatma Kontrol Cihazları	74
Baęlı Perde/Panjur Kontrol Cihazları	75
Kablosuz Perde/Panjur Kontrol Cihazları	75
Baęlı Enerji Yönetim Cihazları	75
Baęlı Termostatlar	76
Aę Geçidi Modülleri	76
Kablosuz Senaryo Kontrol Cihazları	76

## Kurulum Aksesuarları

Buatlar	79
Koruma Kılıfları ve Aksesuarlar	79
IP Korumalı Buatlar ve Çerçeveler - Living Light	80
Kurulum Aksesuarları	80

## Teknik Çizimler

Classia by Bticino Kaide ve Çerçeveler	83
Livinglight Kaide ve Çerçeveler	84
Living Now Kaide ve Çerçeveler	87
Light Now Kaide ve Çerçeveler	89

# Tasarım

Minimalizm. Zamansız gzellik.

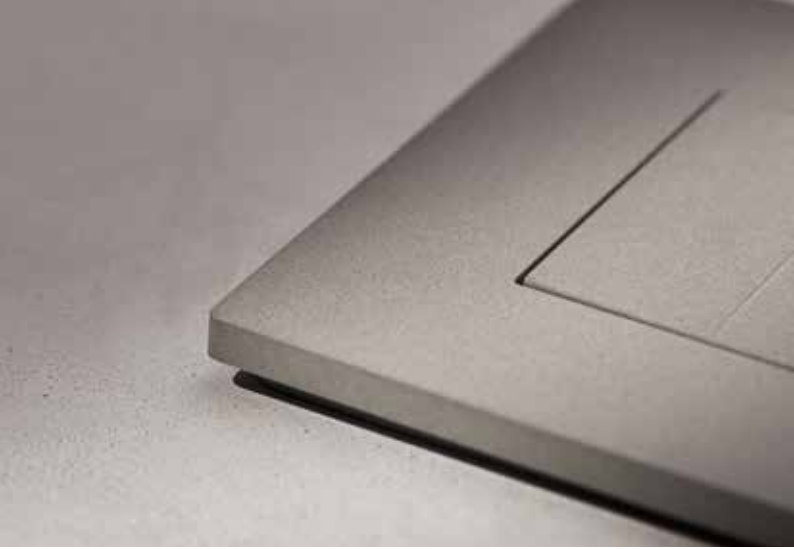

## Saf Tasarım

Her detayın bařrol stlendiđi, minimal ve yalın bir tasarım anlayıřı. Çerçevesel ve mekanizmalar arasında kusursuz hizalama. Hafifçe yuvarlatılmıř křeler ile zarif bir btnlk.



Light Now'ın bu prestijli uluslararası dl kazanması BTicino'nun teknoloji ve tasarımı birleřtirebilme gcn kanıtlar niteliktedir

Dünyanızı aydınlatın. **Şimdi**



**Zamansız** tasarım, **akıllı** teknoloji ve **sürdürülebilir** yaklaşım **Light Now**'da buluşuyor. Mekanlarınızı estetik, konfor ve kontrolle yeniden tanımlayın. **Şimdi.**



**LIGHT now**

Yeşil vizyon ve çevre dostu malzemeler



KARIŞIM

**35% VİSKOZ**  
**65% ORGANİK**  
**BOYA-GERİ**  
**DÖNÜŞTÜRÜLMÜŞ-ABS**



KARIŞIM

**ORGANİK BOYA**  
**GERİ DÖNÜŞTÜRÜLMÜŞ**  
**-ABS**







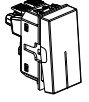
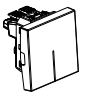
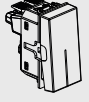
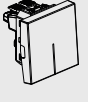
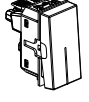
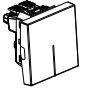
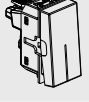
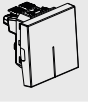

Sosyal medya hesaplarımıza QR kodu taratarak ulaşabilirsiniz

**bticino**

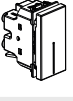
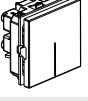

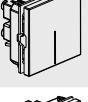

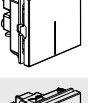
Bir grup markasıdır | **legrand**





## ANAHTARLAR





REF.	STANDART ANAHTARLAR	AMB.	AD/€	REF.	STANDART ANAHTARLAR	AMB.	AD/€		
<input type="checkbox"/> YW4001A		Anahtar, Mekanizma, 10AX, 250V-,	10	7,790	<input type="checkbox"/> YW4001M2A		Anahtar, 10AX, 250V-, Otomatik	10	14,020
<input checked="" type="checkbox"/> YD4001A		Otomatik bağlantı, 1M	10	7,790	<input checked="" type="checkbox"/> YD4001M2A		Bağlantı, 2M	10	14,020
<input checked="" type="checkbox"/> YG4001A			10	8,720	<input checked="" type="checkbox"/> YG4001M2A			10	15,700
<input type="checkbox"/> Y4001A		Anahtar, Mekanizma, 1M	10	4,250	<input type="checkbox"/> -		-	-	-
<input type="checkbox"/> YW4003A		Vavien, 10AX, 250V-, Otomatik	10	8,600	<input type="checkbox"/> YW4003M2A		Vavien, 10AX, 250V-, Otomatik	10	11,470
<input checked="" type="checkbox"/> YD4003A		Bağlantı, 1M	10	8,600	<input checked="" type="checkbox"/> YD4003M2A		Bağlantı, 2M	10	11,470
<input checked="" type="checkbox"/> YG4003A			10	9,630	<input checked="" type="checkbox"/> YG4003M2A			10	12,840
<input type="checkbox"/> Y4003A		Vavien Mekanizma, 1M	10	5,100	<input type="checkbox"/> -		-	-	-
<input type="checkbox"/> YW4004		Permütatör, 10AX, 250V-, Vidalı	10	18,700	<input type="checkbox"/> YW4004M2		Permütatör, 10AX, 250V-, Vidalı	10	23,370
<input checked="" type="checkbox"/> YD4004		Bağlantı, 1M	10	18,700	<input checked="" type="checkbox"/> YD4004M2		Bağlantı, 2M	10	23,370
<input checked="" type="checkbox"/> YG4004			10	20,940	<input checked="" type="checkbox"/> YG4004M2			10	26,170
<input type="checkbox"/> Y4004		Permütatör Mekanizma, 1M	10	14,450	<input type="checkbox"/> -		-	-	-
<input type="checkbox"/> YW4005A		Liht Butonu, 10A, 250V-, Otomatik	10	9,350	<input type="checkbox"/> YW4005M2A		Liht Butonu, 10A, 250V-, Otomatik	10	11,960
<input checked="" type="checkbox"/> YD4005A		Bağlantı, NO Kontak, 1M	10	9,350	<input checked="" type="checkbox"/> YD4005M2A		Bağlantı, NO Kontak, 2M	10	11,960
<input checked="" type="checkbox"/> YG4005A			10	10,470	<input checked="" type="checkbox"/> YG4005M2A			10	13,390
<input type="checkbox"/> Y4005A		Liht Mekanizma, 1M	10	5,100	<input type="checkbox"/> -		-	-	-

REF.	AXIAL ANAHTARLAR	AMB.	AD/€	REF.	AXIAL ANAHTARLAR	AMB.	AD/€		
<input type="checkbox"/> YW4051A		Axial Anahtar, 10AX, 250V-,	10	11,650	<input type="checkbox"/> YW4051M2A		Axial Anahtar, 10AX, 250V-, Otomatik	10	18,230
<input checked="" type="checkbox"/> YD4051A		Otomatik Bağlantı, 1M	10	11,650	<input checked="" type="checkbox"/> YD4051M2A		Bağlantı, 2M	10	18,230
<input checked="" type="checkbox"/> YG4051A			10	13,050	<input checked="" type="checkbox"/> YG4051M2A			10	20,420
<input type="checkbox"/> Y4051A			10	6,360	<input type="checkbox"/> Y4051M2A			10	9,940
<input type="checkbox"/> YW4053A		Axial Vavien, 10AX, 250V-, Otomatik	10	12,860	<input type="checkbox"/> YW4053M2A		Axial Vavien, 10AX, 250V-, Otomatik	10	14,910
<input checked="" type="checkbox"/> YD4053A		Bağlantı, 1M	10	12,860	<input checked="" type="checkbox"/> YD4053M2A		Bağlantı, 2M	10	14,910
<input checked="" type="checkbox"/> YG4053A			10	14,400	<input checked="" type="checkbox"/> YG4053M2A			10	16,700
<input type="checkbox"/> Y4053A			10	6,630	<input type="checkbox"/> Y4053M2A			10	8,810
<input type="checkbox"/> YW4054		Axial Permütatör, 10AX, 250V-,	10	31,600	<input type="checkbox"/> YW4054M2		Axial Permütatör, 10AX, 250V-, O-	10	30,380
<input checked="" type="checkbox"/> YD4054		Vidalı Bağlantı, 1M	10	31,600	<input checked="" type="checkbox"/> YD4054M2		tomatik Bağlantı, 2M	10	30,380
<input checked="" type="checkbox"/> YG4054			10	35,390	<input checked="" type="checkbox"/> YG4054M2			10	34,030
<input type="checkbox"/> Y4054			10	21,610	<input type="checkbox"/> Y4054M2			10	23,480
<input type="checkbox"/> YW4055A		Axial Liht, 10AX, 250V-, Otomatik	10	12,150	<input type="checkbox"/> YW4055M2A		Axial Liht, 10AX, 250V-, Otomatik	10	15,540
<input checked="" type="checkbox"/> YD4055A		Bağlantı, NO Kontak, 1M	10	12,150	<input checked="" type="checkbox"/> YD4055M2A		Bağlantı, NO Kontak, 2M	10	15,540
<input checked="" type="checkbox"/> YG4055A			10	13,610	<input checked="" type="checkbox"/> YG4055M2A			10	17,410
<input type="checkbox"/> Y4055A			10	6,630	<input type="checkbox"/> Y4055M2A			10	8,480











## DİĞER ANAHTARLAR

REF.	2 KUTUPLU ANAHTARLAR	AMB.	AD/€	REF.	KİLİTLİ VAVİEN	AMB.	AD/€
□ YW4002 ■ YD4002 ■ YG4002	 İki Kutuplu Anahtar, 16AX, 250V~, Vidalı Bağlantı, 1M	10	15,760 15,760 17,650	□ YW4022 ■ YD4022 ■ YG4022	 Kilitli Vaviyen, 16AX, 250V~, Vidalı Bağlantı, 1M	1	180,260 180,260 201,890
□ YW4012 ■ YD4012 ■ YG4012	 Kilitli İki Kutuplu Anahtar, 16AX, 250V~, 1M	1	183,880 183,880 205,950				
□ YW4011 ■ YD4011 ■ YG4011	 İki Kutuplu Anahtar, 32A, 250V~, 2M	10	43,800 43,800 49,060				

REF.	JALUZİ KUMANDA ANAHTARLARI	AMB.	AD/€	REF.	FAN KONTROL ANAHTARLARI	AMB.	AD/€
□ YW4027N ■ YD4027N ■ YG4027N	 Jaluzi Kumanda Anahtarı, 10AX, 250V~, Enversör Tip (1-0-2), 1M	10	21,740 21,740 24,350	□ YW4017 ■ YD4017 ■ YG4017	 Çevirmeli Fan Kontrol Anahtarı, 3A, 250V~, Vidalı Bağlantı, Dört Kademeli, 2M	1	48,130 48,130 53,910
□ YW4037N ■ YD4037N ■ YG4037N	 Mekanik Kilitlemeli Jaluzi Kumanda Anahtarı, 10A, 250V~, Vidalı Bağlantı, NO+NO Kontak, 1M	10	24,720 24,720 27,690				
□ YW4027NM2 ■ YD4027NM2 ■ YG4027NM2	 Jaluzi Kumanda Anahtarı, 10 AX, 250V~, Enversör Tip (1-0-2), İki Tuşlu, 2M	10	21,740 21,740 24,350				
□ YW4037NM2 ■ YD4037NM2 ■ YG4037NM2	 Jaluzi Kumanda Anahtarı, 16A, 250V~, Enversör Tip (1-0-2), 2M	10	26,940 26,940 30,180				

REF.	LİHT BUTONLARI	AMB.	AD/€	REF.	TEMASSIZ ANAHTARLAR	AMB.	AD/€
□ YW4034A ■ YD4034A ■ YG4034A	 Liht Butonu, 10A, 250V~, Otomatik bağlantı, 1 kutup NO/NC, 1M	10	12,160 12,160 13,620	□ YW4003TL ■ YD4003TL ■ YG4003TL	 Temassız Aydınlatma Anahtarı 200W LED, 2M	1	150,000 150,000 150,000
□ YW4033 ■ YD4033 ■ YG4033	 Liht Butonu, 10A, 250V~, Vidalı Bağlantı, NA Kontak, Kordonlu, 1M	1	28,360 28,360 31,770	□ YW4005TL ■ YD4005TL ■ YG4005TL	 Temassız Kapı Anahtarı, DC kontrol, 2M	1	150,000 150,000 150,000
□ YW4036 ■ YD4036 ■ YG4036	 İkili Liht Butonu, 10A, 250V - NO kontak, 1M	10	24,740 24,740 27,710				





## PRİZLER

REF.	ALMAN STANDARDI	AMB.	AD/€	REF.	AVRUPA / AMERİKA STANDARDI	AMB.	AD/€
<input type="checkbox"/> YW4141 <input checked="" type="checkbox"/> YD4141 <input checked="" type="checkbox"/> YG4141	 Alman Standardı Topraklı Priz, 16A, 250V~, Otomatik Bağlantı, Çocuk Korumalı, 2M	10	10,120 10,120 11,340	<input type="checkbox"/> YW4126 <input checked="" type="checkbox"/> YD4126 <input checked="" type="checkbox"/> YG4126	 Avrupa/Amerika Standardı Priz, 16A, 127/250V~, otomatik Bağlantı, 2M	10	9,940 9,940 11,130
<input type="checkbox"/> YW4141P <input checked="" type="checkbox"/> YD4141P <input checked="" type="checkbox"/> YG4141P	 Alman Standardı Kapaklı Topraklı Priz, 16A, 250V~, Vidalı Bağlantı, Çocuk Korumalı, 2M	10	18,220 18,220 20,400	<input type="checkbox"/> YW4185 <input checked="" type="checkbox"/> YD4185 <input checked="" type="checkbox"/> YG4185	 İkili Avrupa/Amerika Standardı Priz, 16A, 127/250V~, otomatik Bağlantı, 3M	5	23,850 23,850 26,710
○ Y4141R	 Alman Standardı Topraklı Priz, 16A, 250V~, Vidalı Bağlantı, Çocuk Korumalı, Kırmızı, 2M	10	9,200				
○ Y4141G	 Alman Standardı Topraklı Priz, 16A, 250V~, Vidalı Bağlantı, Çocuk Korumalı, Yeşil, 2M	10	9,200				
<input type="checkbox"/> YW4141USB <input checked="" type="checkbox"/> YD4141USB <input checked="" type="checkbox"/> YG4141USB	 Alman Standardı Topraklı Priz, 16A, 250V~+ C Tipi USB Priz 1.5 A, Otomatik Bağlantı, Çocuk Korumalı, Mekanizma, 2M	1	49,540 49,540 55,480				
REF.	FRANSIZ STANDARDI	AMB.	AD/€	REF.	TIRAŞ PRİZİ	AMB.	AD/€
<input type="checkbox"/> YW4142AF <input checked="" type="checkbox"/> YD4142AF <input checked="" type="checkbox"/> YG4142AF <input type="checkbox"/> Y4142AF	 Fransız Standardı Topraklı Priz, 16A, 250V~, Otomatik Bağlantı, Çocuk Korumalı, 2M	10	11,530 11,530 12,910 9,100	<input type="checkbox"/> YW4177 <input checked="" type="checkbox"/> YD4177 <input checked="" type="checkbox"/> YG4177	 Tıraş Prizi, 230V~, 20VA, 3M	1	283,630 283,630 317,660
○ Y4142AFR	 Fransız Standardı Topraklı Priz, 16A, 250V~, Vidalı Bağlantı, Çocuk Korumalı, Kırmızı, 2M	10	12,050				
<input type="checkbox"/> YW4142AFP <input checked="" type="checkbox"/> YD4142AFP <input checked="" type="checkbox"/> YG4142AFP	 Fransız Standardı Kapaklı Topraklı Priz, 16A, 250V~, Vidalı Bağlantı, Çocuk Korumalı, Kırmızı, 2M	5	20,750 20,750 23,240				
<input type="checkbox"/> YW4142M2AF <input checked="" type="checkbox"/> YD4142M2AF <input checked="" type="checkbox"/> YG4142M2AF	 İkili Fransız Standardı Topraklı Priz, 16A, 250V~, Vidalı Bağlantı, Çocuk Korumalı, Kırmızı, 2M	6	26,520 26,520 29,700				
<input type="checkbox"/> YW4142USB <input checked="" type="checkbox"/> YD4142USB <input checked="" type="checkbox"/> YG4142USB	 Fransız Standardı Topraklı Priz, 16A, 250V~+ C Tipi USB Priz 1.5 A, Otomatik Bağlantı, Çocuk Korumalı, Mekanizma, 2M	1	49,540 49,540 55,480				

## TV PRİZLER

REF.	TV PRİZLERİ	AMB.	AD/€
□ YW4202D ■ YD4202D ■ YG4202D	 TV Priz, Yıldız Bağlantı, 1M	1	20,730 20,730 23,210
□ YW4202M2D ■ YD4202M2D ■ YG4202M2D	 TV Priz, Yıldız Bağlantı, 2M	1	23,690 23,690 26,530
□ YW4202P14 ■ YD4202P14 ■ YG4202P14	 TV Priz, 14 dB, Geçişli, 1M	1	21,760 21,760 24,370
□ YW4202P10 ■ YD4202P10 ■ YG4202P10	 TV Priz, 10 dB, Sonlu, 1M	1	21,760 21,760 24,370
□ YW4202F ■ YD4202F ■ YG4202F	 TV Priz, F Tipi, 1M	1	17,620 17,620 19,730

## DATA VE TELEFON PRİZLERİ



REF.	DATA PRİZLERİ	AMB.	AD/€
□ YW4279C5E ■ YD4279C5E ■ YG4279C5E	 Data Priz, CAT5e UTP, Aletsiz, 1M	10	25,720 25,720 28,810
□ YW4279C6 ■ YD4279C6 ■ YG4279C6	 Data Priz, CAT6 UTP, Aletsiz, 1M	10	29,120 29,120 32,620
□ YW4279C6S ■ YD4279C6S ■ YG4279C6S	 Data Priz, CAT6 STP, Aletsiz, 1M	1	41,710 41,710 46,720
□ YW4279C6A ■ YD4279C6A ■ YG4279C6A	 Data Priz, CAT6A UTP, Aletsiz, 1M	10	58,900 58,900 65,960
□ YW4279C6AS ■ YD4279C6AS ■ YG4279C6AS	 Data Priz, CAT6A STP, Aletsiz, 1M	1	51,910 51,910 58,140

REF.	TV / SAT PRİZLERİ	AMB.	AD/€
□ YW4214D ■ YD4214D ■ YG4214D	 TV-SAT Priz, 1M	1	31,500 31,500 35,280
□ YW4217M2D ■ YD4217M2D ■ YG4217M2D	 TV-SAT Priz, 2M	1	34,200 34,200 38,300

REF.	TELEFON PRİZİ	AMB.	AD/€
□ YW4258RJ11 ■ YD4258RJ11 ■ YG4258RJ11	 Telefon Priz, RJ11, 1M	1	26,330 26,330 29,490

REF.	TV / R / SAT PRİZLERİ	AMB.	AD/€
□ YW4210M2D ■ YD4210M2D ■ YG4210M2D	 TV-R-SAT Priz, 2M	1	54,570 54,570 61,120

## FİBER OPTİK PRİZLER

REF.	FİBER OPTİK PRİZLER	AMB.	AD/€
□ YW4268LC ■ YD4268LC ■ YG4268LC	 Fiber Optik Priz, LC, 1M	1	72,930 72,930 81,690
□ YW4268SC ■ YD4268SC ■ YG4268SC	 Fiber Optik Priz, SC, 1M	1	83,850 83,850 93,910
□ YW4268ST ■ YD4268ST ■ YG4268ST	 Fiber Optik Priz, ST, 1M	1	65,050 65,050 72,850

## ELEKTRONİK PRİZLER

REF.	USB ŞARJ PRİZLERİ	AMB.	AD/€
<input type="checkbox"/> YW4191A <input checked="" type="checkbox"/> YD4191A <input checked="" type="checkbox"/> YG4191A		A Tipi USB Şarj Prizi, 3A, 15W, 100-240V~, 1M	1 30,390 30,390 34,030
<input type="checkbox"/> YW4192C <input checked="" type="checkbox"/> YD4192C <input checked="" type="checkbox"/> YG4192C		C Tipi USB Şarj Prizi, 3A, 20W, 100-240V~, 1M	1 56,080 56,080 62,800
<input type="checkbox"/> YW4191AC <input checked="" type="checkbox"/> YD4191AC <input checked="" type="checkbox"/> YG4191AC		A+C Tipi USB Şarj Prizi, 3A, 15W, 100-240V~, 1M	1 46,750 46,750 52,360
<input type="checkbox"/> YW4191AA <input checked="" type="checkbox"/> YD4191AA <input checked="" type="checkbox"/> YG4191AA		A+A Tipi USB Şarj Prizi, 3A, 15W, 100-240V~, 1M	1 43,470 43,470 48,680
<input type="checkbox"/> YW4191CC <input checked="" type="checkbox"/> YD4191CC <input checked="" type="checkbox"/> YG4191CC		C+C Tipi USB Şarj Prizi, 3A, 15W, 100-240V~, 1M	1 50,010 50,010 56,010
<input type="checkbox"/> YW4287C2 <input checked="" type="checkbox"/> YD4287C2 <input checked="" type="checkbox"/> YG4287C2		A+C Tipi USB Şarj Prizi, 3A, 15W, 100-240V~, 2M	1 46,750 46,750 52,360
<input type="checkbox"/> YW4286C2 <input checked="" type="checkbox"/> YD4286C2 <input checked="" type="checkbox"/> YG4286C2		C+C Tipi USB Şarj Prizi, 3A, 15W, 100-240V~, 2M	1 50,010 50,010 56,010
<input type="checkbox"/> YW4294C <input checked="" type="checkbox"/> YD4294C <input checked="" type="checkbox"/> YG4294C		C Tipi USB Şarj Prizi, 45W, 2M	1 90,690 90,690 101,570
<input type="checkbox"/> YW4395CC <input checked="" type="checkbox"/> YD4395CC <input checked="" type="checkbox"/> YG4395CC		C+C Tipi USB Şarj Prizi, 63W, 3M	1 151,830 151,830 170,050





## AUDIO VIDEO PRİZLER

REF.	AUDIO VIDEO PRİZLER	AMB.	AD/€
<input type="checkbox"/> YW4269R <input checked="" type="checkbox"/> YD4269R <input checked="" type="checkbox"/> YG4269R		İkili RCA Konnektör, Kaynak İle Bağlantı, Sarı - Kırmızı Kontak, 1M	1 35,240 35,240 39,470
<input type="checkbox"/> YW4294 <input checked="" type="checkbox"/> YD4294 <input checked="" type="checkbox"/> YG4294		Hoparlör Konnektörü, 1M	1 42,340 42,340 47,420
<input type="checkbox"/> YW4280 <input checked="" type="checkbox"/> YD4280 <input checked="" type="checkbox"/> YG4280		3.5 mm Jack Konnektörü, 1M	1 34,100 34,100 38,190
<input type="checkbox"/> YW4284P <input checked="" type="checkbox"/> YD4284P <input checked="" type="checkbox"/> YG4284P		Önceden sonlandırılmış HDMI Konnektör, 2M	1 57,830 57,830 64,770
<input type="checkbox"/> YW4285P <input checked="" type="checkbox"/> YD4285P <input checked="" type="checkbox"/> YG4285P		USB Data Prizi, 1M	1 46,590 46,590 52,180

## DİMMERLER





REF.	DİMMERLER	AMB.	AD/€	REF.	DİMMERLER	AMB.	AD/€
<input type="checkbox"/> YW4410 <input checked="" type="checkbox"/> YD4410 <input checked="" type="checkbox"/> YG4410		0-10V Dokunmatik Dimmer, 240V~, 300-600W, 2M	1 228,480 228,480 255,890	<input type="checkbox"/> YW4417 <input checked="" type="checkbox"/> YD4417 <input checked="" type="checkbox"/> YG4417		Dimmer DALI, 100-240V, 2M	1 346,660 346,660 388,250
<input type="checkbox"/> YW4418 <input checked="" type="checkbox"/> YD4418 <input checked="" type="checkbox"/> YG4418		Universal Dimmer, 240V~, 3 kablolu, 1M	1 166,930 166,930 186,960				
<input type="checkbox"/> YW4418M2 <input checked="" type="checkbox"/> YD4418M2 <input checked="" type="checkbox"/> YG4418M2		Universal Dimmer, 240V~, 3 kablolu, 2M	1 166,930 166,930 186,960				
<input type="checkbox"/> YW4419M2 <input checked="" type="checkbox"/> YD4419M2 <input checked="" type="checkbox"/> YG4419M2		Universal Dimmer, 240V~, 2 kablolu, 2M	1 166,930 166,930 186,960				

## HAREKET SENSÖRLERİ



REF.	HAREKET SENSÖRLERİ	AMB.	AD/€
<input type="checkbox"/> YW4430N <input checked="" type="checkbox"/> YD4430N <input checked="" type="checkbox"/> YG4430N	 PIR Hareket Sensörü, 8m, 170°, 500W LED, 2M	1	170,000 170,000 170,000
<input type="checkbox"/> YW4432N <input checked="" type="checkbox"/> YD4432N <input checked="" type="checkbox"/> YG4432N	 PIR Hareket Sensörü, Nötrüz, 8m, 170°, 100W LED, 2M	1	175,000 175,000 175,000
<input type="checkbox"/> YW4432SN <input checked="" type="checkbox"/> YD4432SN <input checked="" type="checkbox"/> YG4432SN	 PIR Hareket Sensörü, Nötrüz, Mod ayarı, 8m, 170°, 100W LED, 2M	1	185,000 185,000 185,000
<input type="checkbox"/> YW4431 <input checked="" type="checkbox"/> YD4431 <input checked="" type="checkbox"/> YG4431	 PIR hareket sensörü, Nötrlü, 230VAC, 1M	1	166,930 166,930 186,960

**Not:** Hareket sensörü seçimi konusunda ayrıntılı bilgi için ürün kataloğunu inceleyiniz.

## OTEL ÇÖZÜMLERİ

REF.	ENERGY SAVER	AMB.	AD/€
<input type="checkbox"/> YW4548M2 <input checked="" type="checkbox"/> YD4548M2 <input checked="" type="checkbox"/> YG4548M2	 RFID Energy Saver, 230V~, 2M	1	157,570 157,570 176,480
<input type="checkbox"/> YW4549M2 <input checked="" type="checkbox"/> YD4549M2 <input checked="" type="checkbox"/> YG4549M2	 Mekanik Anahtarlı Energy Saver, 230V~, 2M	1	117,900 117,900 132,050
<input type="checkbox"/> YW4548 <input checked="" type="checkbox"/> YD4548 <input checked="" type="checkbox"/> YG4548	 RFID Energy Saver, 230V~, 3M	1	157,570 157,570 176,480
<input type="checkbox"/> YW4549 <input checked="" type="checkbox"/> YD4549 <input checked="" type="checkbox"/> YG4549	 Mekanik Anahtarlı Energy Saver, 230V~, 3M	1	117,900 117,900 132,050

## İKAZ VE SİNYAL MEKANİZMALARI

REF.	ZİLLER	AMB.	AD/€
<input type="checkbox"/> YW4351V12 <input checked="" type="checkbox"/> YD4351V12 <input checked="" type="checkbox"/> YG4351V12	 Zil, 12V~, 5VA, 80 dB, 1M	10	34,860 34,860 39,040
<input type="checkbox"/> YW4351V230 <input checked="" type="checkbox"/> YD4351V230 <input checked="" type="checkbox"/> YG4351V230	 Zil, 230V~, 8VA, 80 dB, 1M	10	34,860 34,860 39,040



REF.	TAŞINABİLİR LAMBA	AMB.	AD/€
<input type="checkbox"/> Y4380	 Taşınabilir Lamba, 230V~, 2M	1	102,700

## TERMOSTATLAR

REF.	TERMOSTATLAR	AMB.	AD/€
<input type="checkbox"/> YW4441 <input checked="" type="checkbox"/> YD4441 <input checked="" type="checkbox"/> YG4441	 Elektronik Ortam Termostati, 2A, 250V~, 2M	1	187,120 187,120 209,570

REF.	DİMLENEBİLİR OKUMA LAMBASI	AMB.	AD/€
<input type="checkbox"/> YW4362 <input checked="" type="checkbox"/> YD4362 <input checked="" type="checkbox"/> YG4362	 Dimlenebilir Okuma Lambası, 1M	1	278,870 278,870 312,330

REF.	OTEL ÇAĞRI ÜNİTELERİ	AMB.	AD/€
<input type="checkbox"/> Y4373	 Otel Çağrı Göstergesi, 1M	10	29,130
<input type="checkbox"/> YW4027HN <input checked="" type="checkbox"/> YD4027HN <input checked="" type="checkbox"/> YG4027HN	 Otel Çağrı Butonu, 10AX, 250V~, DND/MUR Sembollü, 1M	10	23,320 23,320 26,120

REF.	BUZZER	AMB.	AD/€
<input type="checkbox"/> YW4356V12 <input checked="" type="checkbox"/> YD4356V12 <input checked="" type="checkbox"/> YG4356V12	 Buzzer, 12V~, 5VA, 74 dB, 1M	10	24,710 24,710 27,670
<input type="checkbox"/> YW4356V230 <input checked="" type="checkbox"/> YD4356V230 <input checked="" type="checkbox"/> YG4356V230	 Buzzer, 230V~, 8VA, 75 dB, 1M	10	24,710 24,710 27,670

REF.	MERDİVEN BASAMAĞI LAMB.	AMB.	AD/€
<input type="checkbox"/> YW4382 <input checked="" type="checkbox"/> YD4382 <input checked="" type="checkbox"/> YG4382	 Merdiven Basamağı Aydınlatması, 230V~, 2M	1	57,650 57,650 64,560

## STANDART ANAHTAR TUŞ KAPAKLARI



YW4915



YD4915

REF.	TUŞ KAPAKLARI	AMB.	AD/€	REF.	TUŞ KAPAKLARI	AMB.	AD/€
□ YW4915	Sembolsüz Tuş Kapağı, 1M	10	4,240	□ YW4915M2	Sembolsüz Tuş Kapağı, 2M	10	6,060
■ YD4915			4,240	■ YD4915M2			6,060
■ YG4915			4,750	■ YG4915M2			6,790



YW4915A



YG4915D



YD4915F



YG4915DM2

REF.	SEMBOLLÜ TUŞ KAPAKLARI	AMB.	AD/€	REF.	SEMBOLLÜ TUŞ KAPAKLARI	AMB.	AD/€
□ YW4915A		10	8,740	□ YW4915AM2		10	11,590
■ YD4915A			8,740	■ YD4915AM2			11,590
■ YG4915A			9,790	■ YG4915AM2			12,980
□ YW4915D		10	8,740	□ YW4915DM2		10	11,590
■ YD4915D			8,740	■ YD4915DM2			11,590
■ YG4915D			9,790	■ YG4915DM2			12,980
□ YW4915F		10	8,740	□ YW4915FM2		10	11,590
■ YD4915F			8,740	■ YD4915FM2			11,590
■ YG4915F			9,790	■ YG4915FM2			12,980
□ YW4915R		10	8,740	□ YW4915RM2		10	11,590
■ YD4915R			8,740	■ YD4915RM2			11,590
■ YG4915R			9,790	■ YG4915RM2			12,980
□ YW4915S		10	8,740	□ YW4915SM2		10	11,590
■ YD4915S			8,740	■ YD4915SM2			11,590
■ YG4915S			9,790	■ YG4915SM2			12,980
□ YW4915P		10	8,740	□ YW4915PM2		10	11,590
■ YD4915P			8,740	■ YD4915PM2			11,590
■ YG4915P			9,790	■ YG4915PM2			12,980

## AXIAL ANAHTAR TUŞ KAPAKLARI



YW4916

YD4916

REF.	SEMBOLSÜZ TUŞ KAPAKLARI	AMB.	AD/€	REF.	SEMBOLSÜZ TUŞ KAPAKLARI	AMB.	AD/€
<input type="checkbox"/> YW4916	Sembolsüz Tuş Kapağı, 1M	10	5,520	<input type="checkbox"/> YW4916M2	Işık Sembollü Tuş Kapağı, 2M	10	7,880
<input checked="" type="checkbox"/> YD4916			5,520	<input checked="" type="checkbox"/> YD4916M2			7,880
<input checked="" type="checkbox"/> YG4916			6,180	<input checked="" type="checkbox"/> YG4916M2			8,830



YW4916A





YD4916A

YW4916P

YG4916P

REF.	SEMBOLLÜ TUŞ KAPAKLARI	AMB.	AD/€	REF.	SEMBOLLÜ TUŞ KAPAKLARI	AMB.	AD/€
<input type="checkbox"/> YW4916A		10	11,360	<input type="checkbox"/> YW4916AM2		10	15,060
<input checked="" type="checkbox"/> YD4916A			11,360	<input checked="" type="checkbox"/> YD4916AM2			15,060
<input checked="" type="checkbox"/> YG4916A			12,730	<input checked="" type="checkbox"/> YG4916AM2			16,870
<input type="checkbox"/> YW4916D		10	11,360	<input type="checkbox"/> YW4916DM2		10	15,060
<input checked="" type="checkbox"/> YD4916D			11,360	<input checked="" type="checkbox"/> YD4916DM2			15,060
<input checked="" type="checkbox"/> YG4916D			12,730	<input checked="" type="checkbox"/> YG4916DM2			16,870
<input type="checkbox"/> YW4916F		10	11,360	<input type="checkbox"/> YW4916FM2		10	15,060
<input checked="" type="checkbox"/> YD4916F			11,360	<input checked="" type="checkbox"/> YD4916FM2			15,060
<input checked="" type="checkbox"/> YG4916F			12,730	<input checked="" type="checkbox"/> YG4916FM2			16,870
<input type="checkbox"/> YW4916R		10	11,360	<input type="checkbox"/> YW4916RM2		10	15,060
<input checked="" type="checkbox"/> YD4916R			11,360	<input checked="" type="checkbox"/> YD4916RM2			15,060
<input checked="" type="checkbox"/> YG4916R			12,730	<input checked="" type="checkbox"/> YG4916RM2			16,870
<input type="checkbox"/> YW4916S		10	11,360	<input type="checkbox"/> YW4916SM2		10	15,060
<input checked="" type="checkbox"/> YD4916S			11,360	<input checked="" type="checkbox"/> YD4916SM2			15,060
<input checked="" type="checkbox"/> YG4916S			12,730	<input checked="" type="checkbox"/> YG4916SM2			16,870
<input type="checkbox"/> YW4916P		10	11,360	<input type="checkbox"/> YW4916PM2		10	15,060
<input checked="" type="checkbox"/> YD4916P			11,360	<input checked="" type="checkbox"/> YD4916PM2			15,060
<input checked="" type="checkbox"/> YG4916P			12,730	<input checked="" type="checkbox"/> YG4916PM2			16,870





**BOŞLUK KAPAKLARI**

REF.	BOŞLUK KAPAKLARI	AMB.	AD/€
<input type="checkbox"/> YW4950 <input checked="" type="checkbox"/> YD4950 <input checked="" type="checkbox"/> YG4950	 Boşluk Kapağı, 1M	10	2,030 2,030 2,280
<input type="checkbox"/> YW4950M2 <input checked="" type="checkbox"/> YD4950M2 <input checked="" type="checkbox"/> YG4950M2	 Boşluk Kapağı, 2M	5	8,430 8,430 9,440
<input type="checkbox"/> YW4953 <input checked="" type="checkbox"/> YD4953 <input checked="" type="checkbox"/> YG4953	 Kablo Çıkış Kapağı, 1M	10	12,880 12,880 14,430
<input type="checkbox"/> YW4953M2 <input checked="" type="checkbox"/> YD4953M2 <input checked="" type="checkbox"/> YG4953M2	 Kablo Çıkış Kapağı, 2M	10	15,150 15,150 16,970

**KAİDELER**

REF.	PLASTİK KAİDELER	AMB.	AD/€
○ Y4702	 Plastik Kaide, Vidalı, 2M	10	3,390
○ Y4719	 Plastik Kaide, Vidalı, 3/2M	10	5,210
○ Y4703	 Plastik Kaide, 3M	10	2,090
○ Y4704	 Plastik Kaide, 4M	5	4,080
○ Y4707	 Plastik Kaide, 7M	1	8,760

**DIĞER AKSESUARLAR**

REF.	AYDINLATMA ÇERÇEVESİ	AMB.	AD/€	REF.	KORUYUCU KAPAK	AMB.	AD/€
○ Y4702X	 Aydınlatma çerçevesi, 2M	1	13,780	○ Y4782	 Koruyucu kapak 2M kaide için	30	1,790
○ Y4703X	 Aydınlatma çerçevesi, 3M	1	13,780	○ Y4783	 Koruyucu kapak 3M kaide için	20	1,790

## PLASTİK ÇERÇEVELER

REF.	POLİMER PLASTİK ÇERÇEVELER	AMB.	AD/€	REF.	POLİMER PLASTİK ÇERÇEVELER	AMB.	AD/€
YA4802WW	Çerçeve, Beyaz, 2M	1	7,220	YA4802DS	Çerçeve, Koyu gri, 2M	1	9,170
YA4803WW	Çerçeve, Beyaz, 3M	1	8,710	YA4803DS	Çerçeve, Koyu gri, 3M	1	11,060
YA4819WW	Çerçeve, Beyaz, 3/2M	1	10,880	YA4819DS	Çerçeve, Koyu gri, 3/2M	1	13,830
YA4804WW	Çerçeve, Beyaz, 4M	1	18,280	YA4804DS	Çerçeve, Koyu gri, 4M	1	23,230
YA4807WW	Çerçeve, Beyaz, 7M	1	28,990	YA4807DS	Çerçeve, Koyu gri, 7M	1	36,840
YA4802M2WW	Çerçeve, Beyaz, 2+2M	1	13,050	YA4802M2DS	Çerçeve, Koyu gri, 2+2M	1	16,580
YA4802M3WW	Çerçeve, Beyaz, 2+2+2M	1	23,820	YA4802M3DS	Çerçeve, Koyu gri, 2+2+2M	1	30,260
YA4802M4WW	Çerçeve, Beyaz, 2+2+2+2M	1	46,840	YA4802M4DS	Çerçeve, Koyu gri, 2+2+2+2M	1	59,510
YA4802DD	Çerçeve, Siyah, 2M	1	7,220	YA4802DG	Çerçeve, Koyu yeşil, 2M	1	9,170
YA4803DD	Çerçeve, Siyah, 3M	1	8,710	YA4803DG	Çerçeve, Koyu yeşil, 3M	1	11,060
YA4819DD	Çerçeve, Siyah, 3/2M	1	10,880	YA4819DG	Çerçeve, Koyu yeşil, 3/2M	1	13,830
YA4804DD	Çerçeve, Siyah, 4M	1	18,280	YA4804DG	Çerçeve, Koyu yeşil, 4M	1	23,230
YA4807DD	Çerçeve, Siyah, 7M	1	28,990	YA4807DG	Çerçeve, Koyu yeşil, 7M	1	36,840
YA4802M2DD	Çerçeve, Siyah, 2+2M	1	13,050	YA4802M2DG	Çerçeve, Koyu yeşil, 2+2M	1	16,580
YA4802M3DD	Çerçeve, Siyah, 2+2+2M	1	23,820	YA4802M3DG	Çerçeve, Koyu yeşil, 2+2+2M	1	30,260
YA4802M4DD	Çerçeve, Siyah, 2+2+2+2M	1	46,840	YA4802M4DG	Çerçeve, Koyu yeşil, 2+2+2+2M	1	59,510
YA4802GG	Çerçeve, Taş, 2M	1	8,490	YA4802GS	Çerçeve, Kum taşı, 2M	1	10,270
YA4803GG	Çerçeve, Taş, 3M	1	10,240	YA4803GS	Çerçeve, Kum taşı, 3M	1	12,390
YA4819GG	Çerçeve, Taş, 3/2M	1	12,800	YA4819GS	Çerçeve, Kum taşı, 3/2M	1	15,490
YA4804GG	Çerçeve, Taş, 4M	1	21,510	YA4804GS	Çerçeve, Kum taşı, 4M	1	26,020
YA4807GG	Çerçeve, Taş, 7M	1	34,110	YA4807GS	Çerçeve, Kum taşı, 7M	1	41,260
YA4802M2GG	Çerçeve, Taş, 2+2M	1	15,360	YA4802M2GS	Çerçeve, Kum taşı, 2+2M	1	18,570
YA4802M3GG	Çerçeve, Taş, 2+2+2M	1	28,020	YA4802M3GS	Çerçeve, Kum taşı, 2+2+2M	1	33,890
YA4802M4GG	Çerçeve, Taş, 2+2+2+2M	1	55,100	YA4802M4GS	Çerçeve, Kum taşı, 2+2+2+2M	1	66,650
YA4802WV	Çerçeve, Beyaz elyaf, 2M	1	8,080	YA4802GM	Çerçeve, Moka taşı, 2M	1	10,270
YA4803WV	Çerçeve, Beyaz elyaf, 3M	1	9,750	YA4803GM	Çerçeve, Moka taşı, 3M	1	12,390
YA4819WV	Çerçeve, Beyaz elyaf, 3/2M	1	12,190	YA4819GM	Çerçeve, Moka taşı, 3/2M	1	15,490
YA4804WV	Çerçeve, Beyaz elyaf, 4M	1	20,480	YA4804GM	Çerçeve, Moka taşı, 4M	1	26,020
YA4807WV	Çerçeve, Beyaz elyaf, 7M	1	32,470	YA4807GM	Çerçeve, Moka taşı, 7M	1	41,260
YA4802M2WV	Çerçeve, Beyaz elyaf, 2+2M	1	14,620	YA4802M2GM	Çerçeve, Moka taşı, 2+2M	1	18,570
YA4802M3WV	Çerçeve, Beyaz elyaf, 2+2+2M	1	26,670	YA4802M3GM	Çerçeve, Moka taşı, 2+2+2M	1	33,890
YA4802M4WV	Çerçeve, Beyaz elyaf, 2+2+2+2M	1	52,460	YA4802M4GM	Çerçeve, Moka taşı, 2+2+2+2M	1	66,650
YA4802WM	Çerçeve, Beyaz mika, 2M	1	8,080				
YA4803WM	Çerçeve, Beyaz mika, 3M	1	9,750				
YA4819WM	Çerçeve, Beyaz mika, 3/2M	1	12,190				
YA4804WM	Çerçeve, Beyaz mika, 4M	1	20,480				
YA4807WM	Çerçeve, Beyaz mika, 7M	1	32,470				
YA4802M2WM	Çerçeve, Beyaz mika, 2+2M	1	14,620				
YA4802M3WM	Çerçeve, Beyaz mika, 2+2+2M	1	26,670				
YA4802M4WM	Çerçeve, Beyaz mika, 2+2+2+2M	1	52,460				

LIVING  
now®

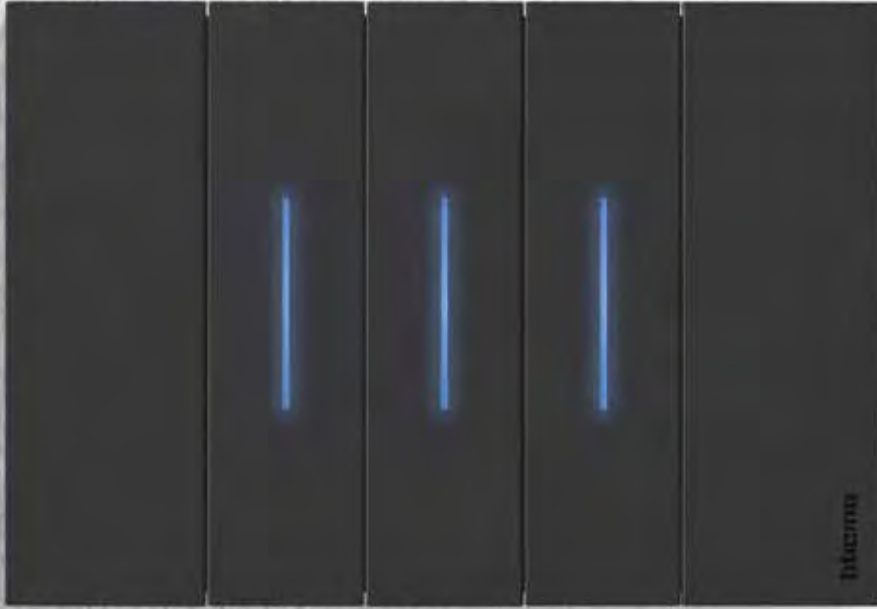

## Zamansız tasarım, akıllı çözümler

Living ailesinin en yeni üyesi olan Living Now, zamansız tasarımının yanı sıra sunmuş olduğu akıllı çözümler ile sektörde bir devrime öncülük ediyor.



- **Yenilikçi tasarım:** mükemmel düzlemsellik ve zarif detaylar
- **Akıllı çözümler:** anahtar - priz ürün gamında ilk bağlı cihazlar!



- **Mükemmel uygulamalar** için en iyi çözümler bir arada

## Yenilikçi tasarım

Mükemmel düzlemsellik ve zarif detaylar



Teknoloji ve tasarımın en iyi şekilde birleştirilmesi ile doğan Living Now, dünyanın en prestijli ödülü olan IF Design Award' u almaya hak kazanmıştır.

### Dokunarak kontrol

Aydınlatmalarınızı tuş kapağı üzerinde herhangi bir noktaya basarak açıp kapatabilirsiniz. Tuş kapağı üzerine basıp çektikten sonra tuş kapağı konumu orijinal pozisyonuna geri döner.

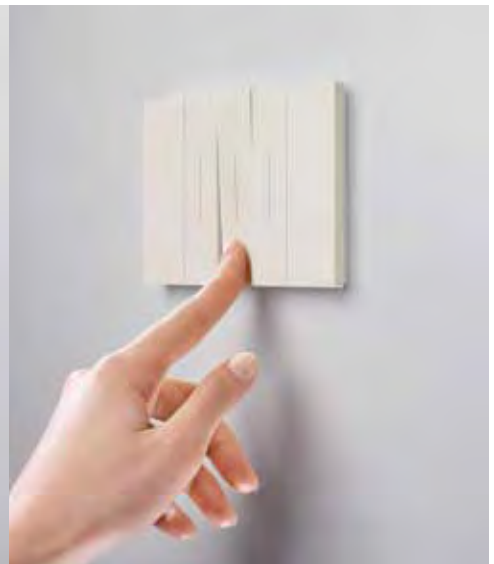

## ANAHTARLAR







REF.	ANAHTARLAR	AMB.	AD/€	REF.	ANAHTARLAR	AMB.	AD/€				
MEKANİZMA	<input type="radio"/> K4001		Anahtar, 10AX, 250V~, Vidalı Bağlantı, Mekanizma, 1M	10	12,740	KAPAK	<input type="checkbox"/> KW01 <input type="checkbox"/> KG01 <input type="checkbox"/> KM01		Anahtar Grubu İçin Kapak, 1M	20	3,860
	<input type="radio"/> K4003		Vavien, 10AX, 250V~, Vidalı Bağlantı, Mekanizma, 1M	10	16,250		<input type="checkbox"/> KW01M2 <input checked="" type="checkbox"/> KG01M2 <input type="checkbox"/> KM01M2		Anahtar Grubu Kapak, 2M	10	6,210
	<input type="radio"/> K4005		Liht Butonu, 10A, 250V~, Vidalı Bağlantı, NA Kontak, Mekanizma, 1M	10	12,740						
	<input type="radio"/> K4004		Permütatör, 10AX, 250V~, Vidalı Bağlantı, Mekanizma, 1M	10	33,350						
	<input type="radio"/> K4004L		Permütatör, 10AX, 250V~, Vidalı Bağlantı, Mekanizma, 1M	10	44,740						
	<input type="radio"/> K4004LB		Permütatör, 10AX, 250V~, Vidalı Bağlantı, Mekanizma, 1M	10	44,740						

\* Mekanizmalar aşağıdaki tabloda yer alan kapaklar ile tamamlanmalıdır.

REF.	KAPAK GÖRSELİ	KAPAK REFERANSLARI		
		BEYAZ	SİYAH	KUM BEJİ
K4001				
K4003		KW01	KG01	KM01
K4005				
K4004				
K4004L		KW01M2	KG01M2	KM01M2
K4004LB				

## DİĞER ANAHTARLAR (DEVAM)



REF.	2 KUTUPLU ANAHTARLAR	AMB.	AD/€	REF.	2 KUTUPLU ANAHTARLAR	AMB.	AD/€
<input type="checkbox"/> KW4002	 İki Kutuplu Anahtar, 16AX, 250V-, Vidalı Bağlantı, Mekanizma, 1M	10	24,700	<b>KAPAK</b> <input type="checkbox"/> KW02 <input checked="" type="checkbox"/> KG02 <input type="checkbox"/> KM02	 KW4033 - KW4113 - KW4180 - K4381 için Kapak, 1M	20	3,860
<input checked="" type="checkbox"/> KG4002	 İki Kutuplu Anahtar, 16AX, 250V-, Vidalı Bağlantı, Mekanizma, 1M	10	24,700				
<input type="checkbox"/> KM4002	 İki Kutuplu Anahtar, 16AX, 250V-, Vidalı Bağlantı, Mekanizma, 1M	10	24,700				

\* Mekanizmalar aşağıdaki tabloda yer alan kapaklar ile tamamlanmalıdır.

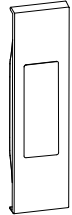
REF.	KAPAK GÖRSELİ	KAPAK REFERANSLARI		
		BEYAZ	SİYAH	KUM BEJİ
KW4002		KW02	-	-
KG4002		-	KG02	-
KM4002		-	-	KG02

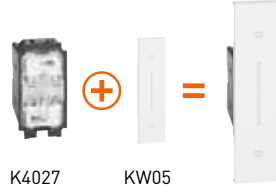
**DiĞER ANAHTARLAR (DEVAM)**







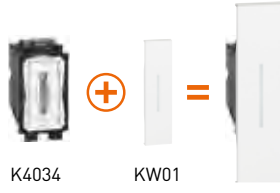

REF.	JALUZİ KUMANDA ANAHTARLARI	AMB.	AD/€	REF.	JALUZİ KUMANDA ANAHTARLARI	AMB.	AD/€		
MEKANİZMA	<input type="radio"/> K4027		Jaluzi Kumanda Anahtarı, 10A, 250V~, Vidalı Bağlantı, Enversör Tip (1-0-2), Mekanizma, 1M	10	37,110	<input type="checkbox"/> KW06 <input checked="" type="checkbox"/> KG06 <input type="checkbox"/> KM06	Enversör Tipi Jaluzi Kumanda Anahtarı İçin Kapak, 1M	10	4,160
	<input type="radio"/> K4037N		Mekanik Kilitlemeli Jaluzi Kumanda Anahtarı, 10A, 250V~, Vidalı Bağlantı, NA+NA Kontak, Mekanizma, 1M	10	45,930	<input type="checkbox"/> KW06V <input checked="" type="checkbox"/> KG06V <input type="checkbox"/> KM06V	Enversör Tipi Jaluzi Kumanda Anahtarı İçin Kapak, Dikey Kullanım, 1M	5	9,670
KAPAK	<input type="checkbox"/> KW06M2V <input checked="" type="checkbox"/> KG06M2V <input type="checkbox"/> KM06M2V		Enversör Tipi Jaluzi Kumanda Anahtarı İçin Kapak, Dikey Kullanım, 2M	5	14,660	<input type="checkbox"/> KW05L <input checked="" type="checkbox"/> KG05L <input type="checkbox"/> KM05L	İkili Liht Butonu İçin Kapak, 1M	5	3,860
	<input type="checkbox"/> KW05 <input checked="" type="checkbox"/> KG05 <input type="checkbox"/> KM05		Jaluzi Kumanda Anahtarı İçin Kapak, 1M	10	3,860	<input type="checkbox"/> KW05M2 <input checked="" type="checkbox"/> KG05M2 <input type="checkbox"/> KM05M2	Jaluzi Kumanda Anahtarı İçin Kapak, 2M	10	14,660
	<input type="checkbox"/> KW05V <input checked="" type="checkbox"/> KG05V <input type="checkbox"/> KM05V		Jaluzi Kumanda Anahtarı İçin Kapak, Dikey Kullanım, 1M	5	9,670	<input type="checkbox"/> KW05M2V <input checked="" type="checkbox"/> KG05M2V <input type="checkbox"/> KM05M2V	Jaluzi Kumanda Anahtarı İçin Kapak, Dikey Kullanım, 2M	5	14,660

\* Mekanizmalar aşağıdaki tabloda yer alan kapaklar ile tamamlanmalıdır.



REF.	KAPAK GÖRSELİ	KAPAK REFERANSLARI		
		BEYAZ	SİYAH	KUM BEJİ
K4027		KW06	KG06	KM06
		KW06V	KG06V	KM06V
		KW06M2V	KG06M2V	KM06M2V
K4037N		KW05	KG05	KM05
		KW05M2	KG05M2	KM05M2
		KW05V	KG05V	KM05V
		KW05M2V	KG05M2V	KM05M2V

## DİĞER ANAHTARLAR (DEVAM)



REF.	LİHT BUTONLARI	AMB.	AD/€	REF.	LİHT BUTONLARI	AMB.	AD/€
<input type="radio"/> K4034	 Liht Butonu, 10A, 250V~, Vidalı Bağlantı, NA+NK Kontak, Mekanizma, 1M	10	18,050	<input type="checkbox"/> KW01 <input checked="" type="checkbox"/> KG01 <input type="checkbox"/> KM01	 Anahtar Grubu için Kapak, 1M	20	3,860
<input type="checkbox"/> KW4033 <input checked="" type="checkbox"/> KG4033 <input type="checkbox"/> KM4033	 Liht Butonu, 10A, 250V~, Vidalı Bağlantı, NA Kontak, Kordonlu, 1M	1	29,330	<input type="checkbox"/> KW02 <input checked="" type="checkbox"/> KG02 <input type="checkbox"/> KM02	 KW4033 - KW4113 - KW4180 - K4381 için Kapak, 1M	20	3,860
REF.	TEMASSIZ ANAHTARLAR	AMB.	AD/€	REF.	TEMASSIZ ANAHTARLAR	AMB.	AD/€
<input type="radio"/> K4003TL	 Temassız Anahtar (Kapı) 12 - 24 - 48 VDC	xx	xx,050	<input type="checkbox"/> KW70M2 <input checked="" type="checkbox"/> KG70M2 <input type="checkbox"/> KM70M2	 K4003TL ve K4005TL için Kapak	20	3,860
<input type="radio"/> K4005TL	 Temassız Anahtar (Aydınlatma) 200 W LED	xx	xx				

\* Mekanizmalar aşağıdaki tabloda yer alan kapaklar ile tamamlanmalıdır.

REF.	KAPAK GÖRSELİ	KAPAK REFERANSLARI		
		BEYAZ	SİYAH	KUM BEJİ
K4034		KW01	KG01	KM01
KW4033		KW02	-	-
KG4033		-	KG02	-
KM4033		-	-	KM02
K4003TL				
K4005TL		KW70M2	KG70M2	KM70M2

## PRİZLER

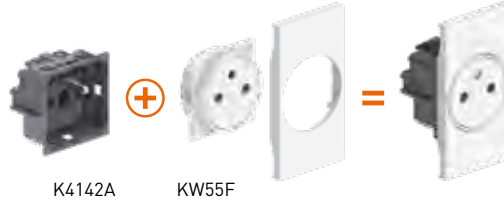

REF.	FRANSIZ STANDARDI	AMB.	AD/€	REF.	FRANSIZ STANDARDI	AMB.	AD/€
MEKANİZMA	<input type="radio"/> K4142A		Fransız Standardı Topraklı Priz, 16A, 250V~, Otomatik Bağlantı, Çocuk Korumalı, Mekanizma, 2M	10	10,220		
	<input type="checkbox"/> KW4142USB		Fransız Standardı Topraklı Priz, 16A, 250V~+ C Tipi USB Priz 1.5 A, Otomatik Bağlantı, Çocuk Korumalı, Mekanizma, 2M	1	56,530		
	<input type="checkbox"/> KG4142USB						
	<input type="checkbox"/> KM4142USB						
KAPAK	<input type="checkbox"/> KW55F		Düz Yüzeyle Fransız Standardı Topraklı Priz için Kapak, 2M	5	15,370		
	<input type="checkbox"/> KG55F						
	<input type="checkbox"/> KM55F						
	<input type="checkbox"/> KR55F						
	<input type="checkbox"/> KV55F						
	<input type="checkbox"/> KW55M3F		Düz Yüzeyle Fransız Standardı Topraklı Priz için Kapak, 3M	5	16,680		
	<input type="checkbox"/> KG55M3F						
	<input type="checkbox"/> KM55M3F						
<input type="checkbox"/> KW55P		Düz Yüzeyle Fransız Standardı Topraklı Priz için Kapaklı Kapak, 2M	1	19,760			
<input type="checkbox"/> KG55P							
<input type="checkbox"/> KM55P							
<input type="checkbox"/> KW62		K*4142USB için Kapak, 2M	5	5,210			
<input type="checkbox"/> KG62							
<input type="checkbox"/> KM62							

\* Mekanizmalar aşağıdaki tabloda yer alan kapaklar ile tamamlanmalıdır.

REF.	KAPAK GÖRSELİ	KAPAK REFERANSLARI				
		BEYAZ	SİYAH	KUM BEJİ	KIRMIZI	YEŞİL
K4142A		KW55F/KW55M3F	-	-	-	-
		-	KG55F/KG55M3F	-	-	-
		-	-	KM55F/KM55M3F	-	-
		-	-	-	KR55F	-
		KW55P	-	-	-	-
		-	KG55P	-	-	-
		-	-	KM55P	-	-
		-	-	-	-	KV55F
KW4142USB		KW62	-	-	-	
KG4142USB		-	KG62	-	-	
KM4142USB		-	-	KM62	-	

## PRİZLER (DEVAM)



MEKANİZMA	REF.	AVRUPA / AMERİKA STANDARDI	AMB.	AD/€	KAPAK	REF.	AVRUPA / AMERİKA STANDARDI	AMB.	AD/€										
<input type="checkbox"/> KW4126 <input checked="" type="checkbox"/> KG4126 <input type="checkbox"/> KM4126		Avrupa/Amerika Standardı Priz, 16A, 127/250V~, Vidalı Bağlantı, 2M	10	13,650	<input type="checkbox"/> KW51 <input checked="" type="checkbox"/> KG51 <input type="checkbox"/> KM51		Euro/Amerikan Standardı Priz Kapak, 2M	1	6,070										
										<input type="checkbox"/> KW4185 <input checked="" type="checkbox"/> KG4185 <input type="checkbox"/> KM4185		İkili Avrupa/Amerika Standardı Priz, 16A, 127/250V~, Vidalı Bağlantı, 3M	5	28,770	<input type="checkbox"/> KW52 <input checked="" type="checkbox"/> KG52 <input type="checkbox"/> KM52		İkili Euro/Amerikan Standardı Priz için Kapak, 3M	10	4,860

\* Mekanizmalar aşağıdaki tabloda yer alan kapaklar ile tamamlanmalıdır.

SEÇİM TABLOSU	REF.	KAPAK GÖRSELİ	KAPAK REFERANSLARI			
			BEYAZ	SİYAH	KUM BEJİ	
<input type="checkbox"/> KW4126 <input checked="" type="checkbox"/> KG4126 <input type="checkbox"/> KM4126 <input type="checkbox"/> KW4185 <input checked="" type="checkbox"/> KG4185 <input type="checkbox"/> KM4185			KW51	—	—	
			—	KG51	—	
			—	—	KM51	
				KW52	—	—
				—	KG52	—
				—	—	KM52

## PRİZLER (DEVAM)



REF.	ALMAN STANDARTI	AMB.	AD/€	REF.	ALMAN STANDARTI	AMB.	AD/€										
MEKANİZMA	<input type="checkbox"/> KW4141TR <input checked="" type="checkbox"/> KG4141TR <input type="checkbox"/> KM4141TR <input checked="" type="checkbox"/> KR4141 <input checked="" type="checkbox"/> KV4141	Alman Standardı Topraklı Priz, 16A, 250V~, Vidalı Bağlantı, Çocuk Korumalı, 2M	10	9,860	<input type="checkbox"/> KW04 <input checked="" type="checkbox"/> KG04 <input type="checkbox"/> KM04 <input checked="" type="checkbox"/> KR04 <input checked="" type="checkbox"/> KV04	K4380 - K*4141TR için Kapak, 2M	10	5,520									
	<input type="checkbox"/> KW4141USB <input checked="" type="checkbox"/> KG4141USB <input type="checkbox"/> KM4141USB				Alman Standardı Topraklı Priz, 16A, 250V~+ C Tipi USB Priz 1.5 A, Otomatik Bağlantı, Çocuk Korumalı, Mekanizma, 2M				1	56,530	<input type="checkbox"/> KW04M3 <input checked="" type="checkbox"/> KG04M3 <input type="checkbox"/> KM04M3	K4380 - K*4141TR için Kapak, 3M	1	7,820			
											<input type="checkbox"/> KW04P <input checked="" type="checkbox"/> KG04P <input type="checkbox"/> KM04P				K*4141TR için Kapaklı Kapak, 2M	1	9,120
											<input type="checkbox"/> KW63 <input checked="" type="checkbox"/> KG63 <input type="checkbox"/> KM63						

\* Mekanizmalar aşağıdaki tabloda yer alan kapaklar ile tamamlanmalıdır.

REF.	KAPAK GÖRSELİ	KAPAK REFERANSLARI				
		BEYAZ	SİYAH	KUM BEJİ	KIRMIZI	YEŞİL
KW4141TR		KW04/ KW04M3		—	—	—
KG4141TR		—	KG04/ KG04M3		—	—
KM4141TR		—	—	KM04/ KM04M3		—
KR4141		—	—	—	KR04	
KV4141		—	—	—	—	KV04
KW4141TR		KW04P		—	—	—
KG4141TR		—	KG04P		—	—
KM4141TR		—	—	KM04P		—
KW4141USB		KW63		—	—	—
KG4141USB		—	KG63		—	—
KM4141USB		—	—	KM63		—

## TV PRİZLER















REF.	TV PRİZLERİ	AMB.	AD/€	REF.	TV PRİZLERİ	AMB.	AD/€
○ K4202D	TV Prizi, Yıldız Bağlantı, Mekanizma, 1M	1	37,800	<input type="checkbox"/> KW08 <input checked="" type="checkbox"/> KG08 <input type="checkbox"/> KM08	TV Prizi ve Kablo Çıkış Modülü İçin Kapak, 1M	10	7,750
○ K4202P14	TV Prizi, 14 dB, Geçişli, Mekanizma, 1M	1	55,060	<input type="checkbox"/> KW09 <input checked="" type="checkbox"/> KG09 <input type="checkbox"/> KM09	TV-SAT Prizi İçin Kapak, 1M	10	7,750
○ K4202P10	TV Prizi, 10 dB, Sonlu, Mekanizma, 1M	1	55,060	<input type="checkbox"/> KW08M2 <input checked="" type="checkbox"/> KG08M2 <input type="checkbox"/> KM08M2	TV Prizi İçin Kapak, 2M	10	9,170
○ K4202F	TV Prizi, F Tipi, Mekanizma, 1M	1	21,770	<input type="checkbox"/> KW25M2 <input checked="" type="checkbox"/> KG25M2 <input type="checkbox"/> KM25M2	İki Delikli TV Priz Kapağı, 2M	10	5,210
○ K4214D	TV-SAT Prizi, Mekanizma, 1M	1	56,190	<input type="checkbox"/> KW26M2 <input checked="" type="checkbox"/> KG26M2 <input type="checkbox"/> KM26M2	TV-R-SAT Prizi İçin Kapak, 2M	10	5,820
○ K4211M2C	TV-Radyo Priz, Mekanizma, 2M	1	54,380				
○ K4210M2D	TV-R-SAT Prizi, 2M	1	54,380				

\* Mekanizmalar aşağıdaki tabloda yer alan kapaklar ile tamamlanmalıdır.

REF.	KAPAK GÖRSELİ	KAPAK REFERANSLARI		
		BEYAZ	SİYAH	KUM BEJİ
K4202D		KW08	KG08	KM08
K4202P14				
K4202P10				
K4202F		KW08M2	KG08M2	KM08M2
KW08M2				
K4214D				
K4211M2C				
K4210M2D		KW26M2	KW26M2	KW26M2

**DATA VE TELEFON PRİZLER**

REF.	DATA VE TELEFON PRİZLER	AMB.	AD/€	REF.	DATA VE TELEFON PRİZLER	AMB.	AD/€
<input type="checkbox"/> KW4279C5E <input checked="" type="checkbox"/> KG4279C5E <input type="checkbox"/> KM4279C5E	 Data Prizi, CAT5e UTP, Aletsiz, 1M	10	10,940	<input type="checkbox"/> KW07 <input checked="" type="checkbox"/> KG07 <input type="checkbox"/> KM07	 Data, Telefon ve Audio/Video Prizleri İçin Kapak, 1M	10	7,400
<input type="checkbox"/> KW4279C6 <input checked="" type="checkbox"/> KG4279C6 <input type="checkbox"/> KM4279C6	 Data Prizi, CAT6 UTP, Aletsiz, 1M	10	17,250	<input type="checkbox"/> KW07M2 <input checked="" type="checkbox"/> KG07M2 <input type="checkbox"/> KM07M2	 Data, Telefon ve Audio/Video Prizleri İçin Kapak, 2M	10	7,400
<input type="checkbox"/> KW4279C6S <input checked="" type="checkbox"/> KG4279C6S <input type="checkbox"/> KM4279C6S	 Data Prizi, CAT6 STP, Aletsiz, 1M	1	23,690	<input type="checkbox"/> KW13M2 <input checked="" type="checkbox"/> KG13M2 <input type="checkbox"/> KM13M2	 Fiber Optik Prizleri İçin Kapak, 2M	10	6,740
<input type="checkbox"/> KW4279C6A <input checked="" type="checkbox"/> KG4279C6A <input type="checkbox"/> KM4279C6A	 Data Prizi, CAT6A UTP, Aletsiz, 1M	10	34,300				
<input type="checkbox"/> KW4279C6AS <input checked="" type="checkbox"/> KG4279C6AS <input type="checkbox"/> KM4279C6AS	 Data Prizi, CAT6A STP, Aletsiz, 1M	1	41,290				
<input type="checkbox"/> KW4258RJ11 <input checked="" type="checkbox"/> KG4258RJ11 <input type="checkbox"/> KM4258RJ11	 Telefon Prizi, RJ11, 1M	1	25,830				
<input type="checkbox"/> KW07K <input checked="" type="checkbox"/> KG07K <input type="checkbox"/> KM07K	 Data Prizi, Jacksız (Keystone), 1M	10	7,400				
<input type="radio"/> K4268SCA2	İkili Fiber Optik Priz, 2M	1	56,470				

REF.	KAPAK GÖRSELİ	KAPAK REFERANSLARI		
		BEYAZ	SİYAH	KUM BEJİ
KW4279C5E	 	KW07/KW07M2	—	—
KG4279C5E		—	KG07/KG07M2	—
KM4279C5E		—	—	KM07/KM07M2
KW4279C6		KW07/KW07M2	—	—
KG4279C6		—	KG07/KG07M2	—
KM4279C6		—	—	KM07/KM07M2
KW4279C6S		KW07/KW07M2	—	—
KG4279C6S		—	KG07/KG07M2	—
KM4279C6S		—	—	KM07/KM07M2
KW4279C6A		KW07/KW07M2	—	—
KG4279C6A		—	KG07/KG07M2	—
KM4279C6A		—	—	KM07/KM07M2
KW4279C6AS		KW07/KW07M2	—	—
KG4279C6AS		—	KG07/KG07M2	—
KM4279C6AS		—	—	KM07/KM07M2
KW4258RJ11		KW07/KW07M2	—	—
KG4258RJ11		—	KG07/KG07M2	—
KM4258RJ11		—	—	KM07/KM07M2

## ELEKTRONİK PRİZLER



K4191A



KW11C

REF.	ELEKTRONİK PRİZLER	AMB.	AD/€	REF.	ELEKTRONİK PRİZLER	AMB.	AD/€
○ K4192C	C tipi USB Şarj Prizi, 3A, 100-240 V~, 1M	1	42,370	KAPAK	□ KW11C	USB Şarj Prizi İçin Kapak, 1M	5 7,660
○ K4191A	A tipi USB Şarj Prizi, 3A, 100-240 V~, 1M	1	35,310		■ KG11C		
○ K4191AC	A+C tipi USB Şarj Prizi, 3A, 100-240 V~, 1M	1	71,910		□ KM11C		
○ K4191CC	C+C tipi USB Şarj Prizi, 3A, 100-240 V~, 1M	1	82,730		□ KW13C	2xUSB Şarj Prizi İçin Kapak, 1M	5 7,750
○ K4191AA	A+A tipi USB Şarj Prizi, 3A, 100-240 V~, 1M	1	63,630		■ KG13C		
				□ KM13C			

## AUDIO VIDEO PRİZLER



K4284P



KW14



REF.	AUDIO / VIDEO PRİZLER	AMB.	AD/€	REF.	AUDIO / VIDEO PRİZLER	AMB.	AD/€
□ KW4269R	İkilili RCA Konnektör, Beyaz - Kırmızı Kontak, 1M	1	21,550	KAPAK	□ KW07	10	7,400
■ KG4269R					■ KG07		
□ KM4269R					□ KM07		
□ KW4294	Hoparlör Konnektörü, 1M	1	17,710		□ KW14	5	7,400
■ KG4294					■ KG14		
□ KM4294				□ KM14			
○ K4284P	HDMI Konnektör, Mekanizma, 1M	1	57,080	□ KW10P	5	7,400	
○ K4285P	USB Konnektör, Mekanizma, 1M	1	43,910	■ KG10P			
				□ KM10P			

\* Mekanizmalar aşağıdaki tabloda yer alan kapaklar ile tamamlanmalıdır.

REF.	KAPAK GÖRSELİ	KAPAK REFERANSLARI		
		BEYAZ	SİYAH	KUM BEJİ
KW4269R		KW07	—	—
KG4269R		—	KG07	—
KM4269R		—	—	KM07
KW4294		KW07	—	—
KG4294		—	KG07	—
KM4294		—	—	KM07
K4284P		KW14	KG14	KM14
K4285P		KW10P	KG10P	KM10P

**DİMMERLER**

REF.	DİMMERLER	AMB.	AD/€	REF.	DİMMERLER	AMB.	AD/€		
MEKANİZMA	<input type="radio"/> K4419M2		1	173,080	KAPAK	<input type="checkbox"/> KW01M2P	Dimmer İçin Kapak, 2M	5	8,950
	<input type="radio"/> K4410		1	173,080		<input type="checkbox"/> KW19			
					<input checked="" type="checkbox"/> KG01M2P				
					<input type="checkbox"/> KM01M2P				
					<input type="checkbox"/> KW19				
					<input checked="" type="checkbox"/> KG19				
					<input type="checkbox"/> KM19				

\* Mekanizmalar aşağıdaki tabloda yer alan kapaklar ile tamamlanmalıdır.

REF.	KAPAK GÖRSELİ	KAPAK REFERANSLARI			
		BEYAZ	SİYAH	KUM BEJİ	
SEÇİM TABLOSU	K4410		KW19	KG19	KM19
	K4419M2		KW01M2P	KG01M2P	KM01M2P

**Not:** Dimmer seçimi konusunda ayrıntılı bilgi için ürün kataloğunu inceleyiniz.



**TERMOSTATLAR**

KG4441

REF.	TERMOSTATLAR	AMB.	AD/€
<input type="checkbox"/> KW4441		1	187,310
<input checked="" type="checkbox"/> KG4441			
<input type="checkbox"/> KM4441			

## HAREKET SENSÖRLERİ

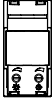

REF.	HAREKET SENSÖRLERİ	AMB.	AD/€	REF.	HAREKET SENSÖRLERİ	AMB.	AD/€
<b>MEKANİZMA</b> ○ K4431	 PIR Hareket Sensörü, 2A, 230V~, 460W, 6m, 105°, Mekanizma, 1M	1	135,250	<b>KAPAK</b> □ KW16 ■ KG16 □ KM16	 Hareket Dedektörü İçin Kapak, 1M	10	7,750

\* Mekanizmalar aşağıdaki tabloda yer alan kapaklar ile tamamlanmalıdır.

REF.	KAPAK GÖRSELİ	KAPAK REFERANSLARI		
		BEYAZ	SİYAH	KUM BEJİ
K4431		KW16	KG16	KM16
K4432		KW17	KG17	KM17
K4430		KW17SL çalışma durumu anahtarı gözükür	KG17SL çalışma durumu anahtarı gözükür	KM17SL çalışma durumu anahtarı gözükür

**Not:** Hareket sensörü seçimi konusunda ayrıntılı bilgi için ürün kataloğunu inceleyiniz.

**OTEL ÇÖZÜMLERİ**

REF.	OTEL ÇÖZÜMLERİ	AMB.	AD/€	REF.	OTEL ÇÖZÜMLERİ	AMB.	AD/€
○ K4549	Mekanik Anahtarlı Energy Saver, 230V~, Mekanizma, 2M	1	166,090	<input type="checkbox"/> KW22M2 <input checked="" type="checkbox"/> KG22M2 <input type="checkbox"/> KM22M2	Energy Saver Kapak, 2M	5	26,960
○ K4548	RFID Energy Saver, 230V~, Mekanizma, 2M	1	178,280	<input type="checkbox"/> KW22 <input checked="" type="checkbox"/> KG22 <input type="checkbox"/> KM22	Energy Saver Kapak, 3M	5	31,470
○ K4027H	Otel Çağrı Butonu, 10Ax, 250V~, DND/MUR Sembollü, Mekanizma, 1M	1	42,760	<input type="checkbox"/> KW06H <input checked="" type="checkbox"/> KG06H <input type="checkbox"/> KM06H	Otel Çağrı Gösterge Butonu İçin Kapak, 1M	5	5,930
○ K4373	Otel Çağrı Göstergesi, Mekanizma, 1M	1	65,860	<input type="checkbox"/> KW11H <input checked="" type="checkbox"/> KG11H <input type="checkbox"/> KM11H	Otel Çağrı Gösterge Lambası İçin Kapak, 1M	5	5,930
<input type="checkbox"/> KW4177 <input checked="" type="checkbox"/> KG4177 <input type="checkbox"/> KM4177	Tıraş Prizi, 230V~, 20VA, 3M	1	233,120	<input type="checkbox"/> KW02 <input checked="" type="checkbox"/> KG02 <input type="checkbox"/> KM02	K*4362 İçin Kapak, 1M	20	3,860
<input type="checkbox"/> KW4362 <input checked="" type="checkbox"/> KG4362 <input type="checkbox"/> KM4362	Dim edilebilir Okuma Lambası, 1M	1	223,970				

\* Mekanizmalar aşağıdaki tabloda yer alan kapaklar ile tamamlanmalıdır.

REF.	KAPAK GÖRSELİ	KAPAK REFERANSLARI		
		BEYAZ	SİYAH	KUM BEJİ
K4549		KW22/KW22M2	KG22/KG22M2	KM22/KM22M2
K4548				
K4027H		KW06H	KG06H	KM06H
K4373		KW11H	KG11H	KM11H
KW4177		KAPAĞA İHTİYAÇ YOKTUR		
KG4177				
KM4177				
KW4362		KW02		
KG4362			KG02	
KM4362				KM02

## İKAZ VE SİNYAL MEKANİZMALARI

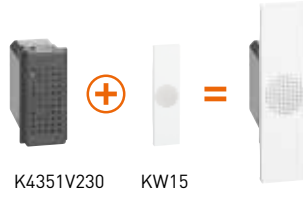

REF.	İKAZ VE SİNYAL MEKANİZMALARI	AMB.	AD/€	REF.	İKAZ VE SİNYAL MEKANİZMALARI	AMB.	AD/€
○ K4351V230	Zil, 230V~, 12VA, 80 dB, Mekanizma, 1M	10	63,970	<input type="checkbox"/> KW15	Zil/Buzzer için Kapak, 1M	10	7,750
○ K4351V12	Zil, 12V~, Mekanizma, 1M	10	63,970	<input type="checkbox"/> KW15M2	Elektronik Zil için Kapak, 2M	10	7,750
○ K4355V12	Elektronik Zil, 12V~/12VDC, 2M	1	166,090	<input type="checkbox"/> KW04	K4380 - KW4141TR için Kapak, 2M	10	5,520
○ K4356V230	Buzzer, 230V~, 12VA, 80 dB, Mekanizma, 1M	10	49,760	<input type="checkbox"/> KW02	KW4033 - KW4113 - KW4180 - K4381 için Kapak, 1M	20	3,860
○ K4356V12	Zil, 12V~, Mekanizma, 1M	10	49,760	<input type="checkbox"/> KW08	K4371 için Kapak, Tek Lamba Kullanımı için, 1M	10	7,750
○ K4380	Taşınabilir Lamba, 230V~, Mekanizma, 2M	1	141,260	<input type="checkbox"/> KW09	K4371 için Kapak, İki Lamba Kullanımı için, 1M	10	7,750
○ 4380NB	K4380N için Batarya	1	14,110	<input type="checkbox"/> KW71	Merdiven Basamağı Aydınlatması için Kapak, 2M	5	13,420
○ K4381	Acil Aydınlatma Lambası, 230V~, 5VA, Mekanizma, 1M	1	127,170	<input type="checkbox"/> KG15			
○ K4371	Sinyal Lambası, LED ile donatılabilir, 1M	1	13,420	<input type="checkbox"/> KG15M2			
○ K4382	Merdiven Basamağı Aydınlatması, 127/230V AC, 2M	10	89,130	<input type="checkbox"/> KM15			

\* Mekanizmalar aşağıdaki tabloda yer alan kapaklar ile tamamlanmalıdır.

REF.	KAPAK GÖRSELİ	KAPAK REFERANSLARI		
		BEYAZ	SİYAH	KUM BEJİ
K4351V230		KW15	KG15	KM15
K4351V12		KW15M2	KG15M2	KM15M2
K4355V12		KW15	KG15	KM15
K4356V230		KW08/KW09	—	—
K4356V12		—	KG08/KG09	—
K4371		—	—	KM08/KM09
K4382		KW71	—	—
		—	KG71	—
		—	—	KM71

**LED LAMBALAR**

K4743V230T



LN4743/230T



H4743/12B



LN4743/12T



H4743/230B



K4743V230RG

REF.	LED LAMBALAR	AMB.	AD/€
○ K4743V230T	Yüksek Işıklı Beyaz LED Lamba, 230V~	10	11,280
○ LN4743/230T	Beyaz LED Lamba, 230V~	10	4,190
○ LN4743/12T	Beyaz LED Lamba, 12V~	10	4,190
○ H4743/230B	Mavi LED Lamba, 230V~	10	4,100
○ H4743/12B	Mavi LED Lamba, 12V~	10	4,100
○ K4743V230RG	Kırmızı/Yeşil LED Lamba, 230V~	10	12,300

**BOŞLUK KAPAKLARI**

REF.	BOŞLUK KAPAKLARI	AMB.	AD/€	REF.	BOŞLUK KAPAKLARI	AMB.	AD/€
○ K4949	Boşluk Kapağı, Mekanizma, 0,5M	10	1,410	<input type="checkbox"/> KW00 <input checked="" type="checkbox"/> KG00 <input type="checkbox"/> KM00	Boşluk Kapağı, 1M	20	3,860
○ K4950	Boşluk Kapağı, Mekanizma, 1M	10	0,620	<input type="checkbox"/> KW00M2 <input checked="" type="checkbox"/> KG00M2 <input type="checkbox"/> KM00M2	Boşluk Kapağı, 2M	20	5,700
○ K4953	Kablo Çıkış Kapağı, Mekanizma, 1M	1	5,080	<input type="checkbox"/> KW08 <input checked="" type="checkbox"/> KG08 <input type="checkbox"/> KM08	TV Prizi ve Kablo Çıkış Modülü İçin Kapak, 1M	10	7,750

\* Mekanizmalar aşağıdaki tabloda yer alan kapaklar ile tamamlanmalıdır.

REF.	KAPAK GÖRSELİ	KAPAK REFERANSLARI		
		BEYAZ	SİYAH	KUM BEJİ
K4949	—	KAPAĞA İHTİYAÇ YOKTUR		
K4950		KW00/KW00M2	KG00/KG00M2	KM00/KM00M2
K4953		KW08	KG08	KM08

## SEMBOLLÜ TUŞ KAPAKLARI



KW01PN KG01RN KM01SN KW01M2PN KG01M2RN KG01M2RN



KW01X KG01A KM01D KW01F KW01M2X KG01M2A KM01M2D KW01M2F

REF.	SEMBOLLÜ TUŞ KAPAKLARI	AMB.	AD/€
<input type="checkbox"/> KW01PN <input checked="" type="checkbox"/> KG01PN <input type="checkbox"/> KM01PN	Isıtma Sembollü Tuş Kapağı, 1M	5	8,960
<input type="checkbox"/> KW01RN <input checked="" type="checkbox"/> KG01RN <input type="checkbox"/> KM01RN	Fan Sembollü Tuş Kapağı, 1M	5	8,960
<input type="checkbox"/> KW01SN <input checked="" type="checkbox"/> KG01SN <input type="checkbox"/> KM01SN	Boiler Sembollü Tuş Kapağı, 1M	5	8,960
<input type="checkbox"/> KW01X <input checked="" type="checkbox"/> KG01X <input type="checkbox"/> KM01X	Şeffaf Pencerele Tuş Kapağı, 1M	5	5,800
<input type="checkbox"/> KW01A <input checked="" type="checkbox"/> KG01A <input type="checkbox"/> KM01A	Lamba Sembollü Tuş Kapağı, 1M	10	5,800
<input type="checkbox"/> KW01D <input checked="" type="checkbox"/> KG01D <input type="checkbox"/> KM01D	Zil Sembollü Tuş Kapağı, 1M	10	5,800
<input type="checkbox"/> KW01F <input checked="" type="checkbox"/> KG01F <input type="checkbox"/> KM01F	Anahtar Sembollü Tuş Kapağı, 1M	10	5,800

REF.	SEMBOLLÜ TUŞ KAPAKLARI	AMB.	AD/€
<input type="checkbox"/> KW01M2PN <input checked="" type="checkbox"/> KG01M2PN <input type="checkbox"/> KM01M2PN	Isıtma Sembollü Tuş Kapağı, 2M	5	11,410
<input type="checkbox"/> KW01M2RN <input checked="" type="checkbox"/> KG01M2RN <input type="checkbox"/> KM01M2RN	Fan Sembollü Tuş Kapağı, 2M	5	11,410
<input type="checkbox"/> KW01M2SN <input checked="" type="checkbox"/> KG01M2SN <input type="checkbox"/> KM01M2SN	Boiler Sembollü Tuş Kapağı, 2M	5	11,410
<input type="checkbox"/> KW01M2X <input checked="" type="checkbox"/> KG01M2X <input type="checkbox"/> KM01M2X	Şeffaf Pencerele Tuş Kapağı, 2M	5	7,710
<input type="checkbox"/> KW01M2A <input checked="" type="checkbox"/> KG01M2A <input type="checkbox"/> KM01M2A	Lamba Sembollü Tuş Kapağı, 2M	10	7,710
<input type="checkbox"/> KW01M2D <input checked="" type="checkbox"/> KG01M2D <input type="checkbox"/> KM01M2D	Zil Sembollü Tuş Kapağı, 2M	5	7,710
<input type="checkbox"/> KW01M2F <input checked="" type="checkbox"/> KG01M2F <input type="checkbox"/> KM01M2F	Anahtar Sembollü Tuş Kapağı, 2M	5	7,710





KAİDELER



K4702



K4704

REF.	KAİDELER	AMB.	AD/€
<input type="radio"/> K4702	 Plastik Kaide, Vidalı, 2M	10	3,510
<input type="radio"/> K4703	 Plastik Kaide, 3M	10	3,510
<input type="radio"/> K4704	 Plastik Kaide, 4M	5	7,750
<input type="radio"/> K4706	 Plastik Kaide, 6M	1	16,250

## POLİMER PLASTİK ÇERÇEVELER

REF.	POLİMER PLASTİK ÇERÇEVELER	AMB.	AD/€	REF.	POLİMER PLASTİK ÇERÇEVELER	AMB.	AD/€
KA4802KW	Çerçeve, Beyaz, 2M	1	9,710	KA4802DM	Çerçeve, Atmosfer, 2M	1	14,770
KA4802M2KW	Çerçeve, 2+2M, Beyaz	1	18,110	KA4802M2DM	Çerçeve, 2+2M, Atmosfer	1	24,850
KA4802M3KW	Çerçeve, 2+2+2M, Beyaz	1	27,570	KA4802M3DM	Çerçeve, 2+2+2M, Atmosfer	1	36,490
KA4802M4KW	Çerçeve, 2+2+2+2M, Beyaz	1	33,250	KA4802M4DM	Çerçeve, 2+2+2+2M, Atmosfer	1	46,150
KA4803KW	Çerçeve, Beyaz, 3M	1	9,710	KA4803DM	Çerçeve, Atmosfer, 3M	1	14,770
KA4804KW	Çerçeve, Beyaz, 4M	1	12,860	KA4804DM	Çerçeve, Atmosfer, 4M	1	19,970
KA4806KW	Çerçeve, Beyaz, 6M	1	19,740	KA4806DM	Çerçeve, Atmosfer, 6M	1	30,680
KA4802KG	Çerçeve, Siyah, 2M	1	9,710	KA4802DA	Çerçeve, Gökyüzü, 2M	1	14,770
KA4802M2KG	Çerçeve, 2+2M, Siyah	1	18,110	KA4802M2DA	Çerçeve, 2+2M, Gökyüzü	1	24,850
KA4802M3KG	Çerçeve, 2+2+2M, Siyah	1	27,570	KA4802M3DA	Çerçeve, 2+2+2M, Gökyüzü	1	36,490
KA4802M4KG	Çerçeve, 2+2+2+2M, Siyah	1	33,250	KA4802M4DA	Çerçeve, 2+2+2+2M, Gökyüzü	1	46,150
KA4803KG	Çerçeve, Siyah, 3M	1	9,710	KA4803DA	Çerçeve, Gökyüzü, 3M	1	14,770
KA4804KG	Çerçeve, Siyah, 4M	1	12,860	KA4804DA	Çerçeve, Gökyüzü, 4M	1	19,970
KA4806KG	Çerçeve, Siyah, 6M	1	19,740	KA4806DA	Çerçeve, Gökyüzü, 6M	1	30,680
KA4802KM	Çerçeve, Kum Beji, 2M	1	9,710	KA4802MM	Çerçeve, Optik, 2M	1	23,240
KA4802M2KM	Çerçeve, 2+2M, Kum Beji	1	18,110	KA4802M2MM	Çerçeve, 2+2M, Optik	1	37,980
KA4802M3KM	Çerçeve, 2+2+2M, Kum Beji	1	27,570	KA4802M3MM	Çerçeve, 2+2+2M, Optik	1	56,150
KA4802M4KM	Çerçeve, 2+2+2+2M, Kum Beji	1	33,250	KA4802M4MM	Çerçeve, 2+2+2+2M, Optik	1	70,540
KA4803KM	Çerçeve, Kum Beji, 3M	1	9,710	KA4803MM	Çerçeve, Optik, 3M	1	23,240
KA4804KM	Çerçeve, Kum Beji, 4M	1	12,860	KA4804MM	Çerçeve, Optik, 4M	1	31,470
KA4806KM	Çerçeve, Kum Beji, 6M	1	19,740	KA4806MM	Çerçeve, Optik, 6M	1	48,410
KA4802DW	Çerçeve, Buz, 2M	1	14,770	KA4802MW	Çerçeve, Piksel, 2M	1	23,240
KA4802M2DW	Çerçeve, 2+2M, Buz	1	24,850	KA4802M2MW	Çerçeve, 2+2M, Piksel	1	37,980
KA4802M3DW	Çerçeve, 2+2+2M, Buz	1	36,490	KA4802M3MW	Çerçeve, 2+2+2M, Piksel	1	56,150
KA4802M4DW	Çerçeve, 2+2+2+2M, Buz	1	46,150	KA4802M4MW	Çerçeve, 2+2+2+2M, Piksel	1	70,540
KA4803DW	Çerçeve, Buz, 3M	1	14,770	KA4803MW	Çerçeve, Piksel, 3M	1	23,240
KA4804DW	Çerçeve, Buz, 4M	1	19,970	KA4804MW	Çerçeve, Piksel, 4M	1	31,470
KA4806DW	Çerçeve, Buz, 6M	1	30,680	KA4806MW	Çerçeve, Piksel, 6M	1	48,410
KA4802DG	Çerçeve, Gece, 2M	1	14,770				
KA4802M2DG	Çerçeve, 2+2M, Gece	1	24,850				
KA4802M3DG	Çerçeve, 2+2+2M, Gece	1	36,490				
KA4802M4DG	Çerçeve, 2+2+2+2M, Gece	1	46,150				
KA4803DG	Çerçeve, Gece, 3M	1	14,770				
KA4804DG	Çerçeve, Gece, 4M	1	19,970				
KA4806DG	Çerçeve, Gece, 6M	1	30,680				

**METAL ÇERÇEVELER**
**AHŞAP ÇERÇEVELER**

REF.	METAL ÇERÇEVELER	AMB.	AD/€
KA4802NW	Çerçeve, Ayışığı, 2M	1	36,370
KA4802M2NW	Çerçeve, 2+2M, Ay Işığı	1	60,540
KA4802M3NW	Çerçeve, 2+2+2M, Ay Işığı	1	89,190
KA4802M4NW	Çerçeve, 2+2+2+2M, Ay Işığı	1	112,750
KA4803NW	Çerçeve, Ayışığı, 3M	1	36,370
KA4804NW	Çerçeve, Ayışığı, 4M	1	48,930
KA4806NW	Çerçeve, Ayışığı, 6M	1	76,060
KA4802NG	Çerçeve, Sis, 2M	1	36,370
KA4802M2NG	Çerçeve, 2+2M, Sis	1	60,540
KA4802M3NG	Çerçeve, 2+2+2M, Sis	1	89,190
KA4802M4NG	Çerçeve, 2+2+2+2M, Sis	1	112,750
KA4803NG	Çerçeve, Sis, 3M	1	36,370
KA4804NG	Çerçeve, Sis, 4M	1	48,930
KA4806NG	Çerçeve, Sis, 6M	1	76,060
KA4802ZG	Çerçeve, Çelik, 2M	1	36,370
KA4802M2ZG	Çerçeve, 2+2M, Çelik	1	60,540
KA4802M3ZG	Çerçeve, 2+2+2M, Çelik	1	89,190
KA4802M4ZG	Çerçeve, 2+2+2+2M, Çelik	1	112,750
KA4803ZG	Çerçeve, Çelik, 3M	1	36,370
KA4804ZG	Çerçeve, Çelik, 4M	1	48,930
KA4806ZG	Çerçeve, Çelik, 6M	1	76,060
KA4802ZM	Çerçeve, Bakır, 2M	1	36,370
KA4802M2ZM	Çerçeve, 2+2M, Bakır	1	60,540
KA4802M3ZM	Çerçeve, 2+2+2M, Bakır	1	89,190
KA4802M4ZM	Çerçeve, 2+2+2+2M, Bakır	1	112,750
KA4803ZM	Çerçeve, Bakır, 3M	1	36,370
KA4804ZM	Çerçeve, Bakır, 4M	1	48,930
KA4806ZM	Çerçeve, Bakır, 6M	1	76,060
KA4802ZW	Çerçeve, Altın, 2M	1	36,370
KA4802M2ZW	Çerçeve, 2+2M, Altın	1	60,540
KA4802M3ZW	Çerçeve, 2+2+2M, Altın	1	89,190
KA4802M4ZW	Çerçeve, 2+2+2+2M, Altın	1	112,750
KA4803ZW	Çerçeve, Altın, 3M	1	36,370
KA4804ZW	Çerçeve, Altın, 4M	1	48,930
KA4806ZW	Çerçeve, Altın, 6M	1	76,060

REF.	AHŞAP ÇERÇEVELER	AMB.	AD/€
KA4802LG	Çerçeve, Ceviz, 2M	1	76,420
KA4802M2LG	Çerçeve, 2+2M, Ceviz	1	113,390
KA4802M3LG	Çerçeve, 2+2+2M, Ceviz	1	160,510
KA4802M4LG	Çerçeve, 2+2+2+2M, Ceviz	1	198,470
KA4803LG	Çerçeve, Ceviz, 3M	1	84,310
KA4804LG	Çerçeve, Ceviz, 4M	1	91,260
KA4806LG	Çerçeve, Ceviz, 6M	1	126,290
KA4802LM	Çerçeve, Meşe, 2M	1	76,420
KA4802M2LM	Çerçeve, 2+2M, Meşe	1	113,390
KA4802M3LM	Çerçeve, 2+2+2M, Meşe	1	160,510
KA4802M4LM	Çerçeve, 2+2+2+2M, Meşe	1	198,470
KA4803LM	Çerçeve, Meşe, 3M	1	84,310
KA4804LM	Çerçeve, Meşe, 4M	1	91,260
KA4806LM	Çerçeve, Meşe, 6M	1	126,290



- Yenilikçi tasarım: mükemmel düzlemsellik ve zarif detaylar.
- Akıllı Çözümler: anahtar-priz ürün gamında ilk bağlı cihazlar!
- Mükemmel uygulamalar için en iyi çözümler bir arada



Home + Control



# LIVINGLIGHT<sup>AIR</sup>

Kusursuzluğun zarif eseri

Zarafet ve teknoloji, LIVINGLIGHT ile bir arada







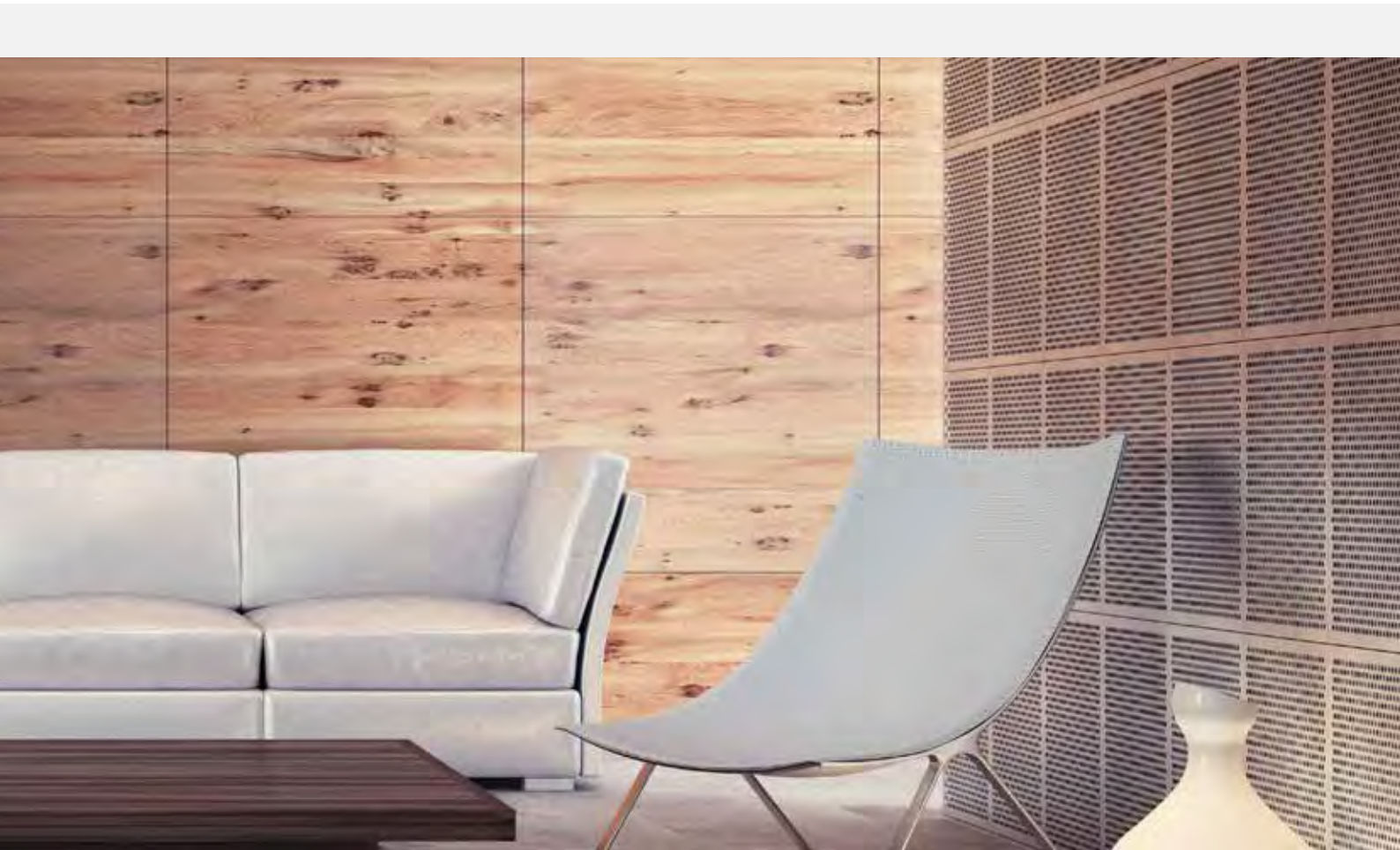

LIVINGLIGHT  
DİK DÖRTGEN  
ÇERÇEVELER





**ANAHTARLAR**

REF.	STANDART ANAHTARLAR	AMB.	AD/€	REF.	STANDART ANAHTARLAR	AMB.	AD/€			
□ N4001A		10	6,640	□ N4001M2A	Anahtar, 16AX, 250V~, Otomatik	10	9,060			
■ L4001A				Anahtar, Mekanizma, 1M	10	6,640	■ L4001M2A	Bağlantı, 2M	10	9,060
■ NT4001A					10	7,310	■ NT4001M2A		10	9,970
○ LN4001A	Anahtar, Mekanizma, 1M	10	5,500	○ -	-	-	-			
□ N4003A		10	8,980	□ N4003M2A	Vavien, 16AX, 250V~, Otomatik	10	9,880			
■ L4003A				Vavien, 16AX, 250V~, Otomatik Bağlantı, 1M	10	8,980	■ L4003M2A	Vavien, 16AX, 250V~, Otomatik Bağlantı, 2M	10	9,880
■ NT4003A					10	9,880	■ NT4003M2A		10	10,880
○ LN4003A	Vavien Mekanizma, 1M	10	7,000	○ -	-	-	-			
□ N4004N		10	14,940	□ N4004M2N	Permütatör, 16AX, 250V~, Vidalı	10	19,330			
■ L4004N				Permütatör, 16AX, 250V~, Vidalı Bağlantı, 1M	10	14,940	■ L4004M2N	Permütatör, 16AX, 250V~, Vidalı Bağlantı, 2M	10	19,330
■ NT4004N					10	16,430	■ NT4004M2N		10	21,260
○ LN4004	Permütatör Mekanizma, 1M	10	13,050	○ -	-	-	-			
□ N4005A		10	6,800	□ N4005M2A	Liht Butonu, 10A, 250V~, Otomatik	10	8,090			
■ L4005A				Liht Butonu, 10A, 250V~, Otomatik Bağlantı, NA Kontak, 1M	10	6,800	■ L4005M2A	Liht Butonu, 10A, 250V~, Otomatik Bağlantı, NA Kontak, 2M	10	8,090
■ NT4005A					10	7,480	■ NT4005M2A		10	8,900
○ LN4005A	Liht Mekanizma, 1M	10	5,500	○ -	-	-	-			

REF.	AXIAL ANAHTARLAR	AMB.	AD/€	REF.	AXIAL ANAHTARLAR	AMB.	AD/€					
□ N4051AN		10	10,740	□ N4051M2AN	Axial Anahtar, 10AX, 250V~, Otomatik	10	12,330					
■ L4051AN				Axial Anahtar, 10AX, 250V~, Otomatik Bağlantı, 1M	10			10,740	■ L4051M2AN	Axial Anahtar, 10AX, 250V~, Otomatik Bağlantı, 2M	10	12,330
■ NT4051AN					10			14,070	■ NT4051M2AN		10	15,740
□ N4053AN		10	13,400	□ N4053M2AN	Axial Vavien, 10AX, 250V~, Otomatik	10	14,710					
■ L4053AN				Axial Vavien, 10AX, 250V~, Otomatik Bağlantı, 1M	10			13,400	■ L4053M2AN	Axial Vavien, 10AX, 250V~, Otomatik Bağlantı, 2M	10	14,710
■ NT4053AN					10			17,320	■ NT4053M2AN		10	18,570
□ N4054		10	26,690	□ N4054M2	Axial Permütatör, 16A, 250V~, Vidalı	10	33,210					
■ L40054				Axial Permütatör, 16A, 250V~, Vidalı Bağlantı, 1M	10			26,690	■ L40054M2	Axial Permütatör, 16A, 250V~, Otomatik Bağlantı, 2M	10	33,210
■ NT4054					10			29,370	■ NT4054M2		10	36,530
□ N4055AN		10	11,560	□ N4055M2AN	Axial Liht, 10A, 250V~, Otomatik	10	13,520					
■ L4055AN				Axial Liht, 10A, 250V~, Otomatik Bağlantı, NA Kontak, 1M	10			11,560	■ L4055M2AN	Axial Liht, 10A, 250V~, Otomatik Bağlantı, NA Kontak, 2M	10	13,520
■ NT4055AN					10			15,120	■ NT4055M2AN		10	17,240



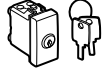

**DİĞER ANAHTARLAR**



REF.	2 KUTUPLU ANAHTARLAR	AMB.	AD/€	REF.	KİLİTLİ VAVİEN	AMB.	AD/€					
□ N4002N		10	12,450	□ N4022	Kilitli Vavien, 16AX, 250V~, Vidalı	1	122,430					
■ L4002N				İki Kutuplu Anahtar, 16AX, 250V~, Vidalı Bağlantı, 1M	10			12,450	■ L4022	Kilitli Vavien, 16AX, 250V~, Vidalı Bağlantı, 1M	1	122,430
■ NT4002N					10			13,700	■ NT4022		1	134,670
□ N4012		1	138,800	□ N4022C*	Kilitli Vavien, 16AX, 250V~, Vidalı	1	137,610					
■ L4012				Kilitli İki Kutuplu Anahtar, 16AX, 250V~, Vidalı Bağlantı, 1M	1			138,800	■ L4022C*	Kilitli Vavien, 16AX, 250V~, Vidalı Bağlantı, 1M	1	137,610
■ NT4012					1			152,680	■ NT4022C*		1	151,380
□ N4012C*		1	137,610	□ N4011	İki Kutuplu Anahtar, 32A, 250V~, Vidalı	10	30,020					
■ L4012C*				Kilitli İki Kutuplu Anahtar, 16AX, 250V~, Vidalı Bağlantı, 1M	1			137,610	■ L4011	İki Kutuplu Anahtar, 32A, 250V~, Vidalı Bağlantı, 1M	10	30,020
■ NT4012C*					1			151,380	■ NT4011		10	33,020











\* Sipariş vermek için lütfen satış ofisimize danışınız.

\* N4022C, NT4022C ve L4022C için tüm anahtarlar standarttır.

## DİĞER ANAHTARLAR (DEVAM)



REF.	JALUZİ KUMANDA ANAHTARLARI	AMB.	AD/€	REF.	FAN KONTROL ANAHTARLARI	AMB.	AD/€
□ N4027N ■ L4027N ■ NT4027N	 Jaluzi Kumanda Anahtarı, 16A, 250V~, Vidalı Bağlantı, Enversör Tip (1-0-2), İki Tuşlu, 1M	10	21,720 21,720 23,880	□ N4027VMCN ■ L4027VMCN ■ NT4027VMCN	 Fan Kontrol Anahtarı, 16A, 250V~, Vidalı Bağlantı, Enversör Tip (1-0-2), İki Tuşlu, 1M	10	21,720 21,720 23,880
□ N4037N ■ L4037N ■ NT4037N	 Mekanik Kilitlemeli Jaluzi Kumanda Anahtarı, 10A, 250V~, Vidalı Bağlantı, NA+NA Kontak, 1M	10	21,720 21,720 23,880	□ N4016 ■ L4016 ■ NT4016	 Çevirmeli Fan Kontrol Anahtarı, 3A, 250V~, Vidalı Bağlantı, Dört Kademeli, 2M	1	50,300 50,300 55,330

REF.	JACK BAĞLANTISI	AMB.	AD/€
□ N4391 ■ L4391 ■ NT4391	 Jack Bağlantısı, 10A, 48V~, Vidalı Bağlantı, İki Kontaklı, 1M	10	27,050 27,050 29,750
○ 2124N	 L/N/NT4391 için Fiş/Jack	10	5,070











REF.	LİHT BUTONLARI	AMB.	AD/€	REF.	LİHT BUTONLARI	AMB.	AD/€
□ N4034N ■ L4034N ■ NT4034N	 Liht Butonu, 10A, 250V~, Vidalı Bağlantı, NK Kontak, Değiştirilebilir Kapak, 1M	10	6,640 6,640 7,310	○ LN4040*	 Etiketli Liht Butonu, 10A, 250V~, Vidalı Bağlantı, NA Kontak, 2M	10	18,500
□ N4033 ■ L4033 ■ NT4033	 Liht Butonu, 10A, 250V~, Vidalı Bağlantı, NA Kontak, Kordonlu, 1M	1	14,820 14,820 16,310	□ N4042N* ■ L4042N* ■ NT4042N*	 Zil Sembollü Liht Butonu, 10A, 250V~, Vidalı Bağlantı, NA Kontak, 1M	10	7,560 7,560 8,810
□ N4038R* ■ L4038R* ■ NT4038R*	 Liht Butonu, 10A, 250V~, Vidalı Bağlantı, NA Kontak, Kırmızı Göstergeli, 1M	10	17,440 17,440 19,190	□ N4042M2N* ■ L4042M2N* ■ NT4042M2N*	 Zil Sembollü Liht Butonu, 10A, 250V~, Vidalı Bağlantı, NA Kontak, 2M	10	8,520 8,520 9,840
□ N4038V* ■ L4038V* ■ NT4038V*	 Liht Butonu, 10A, 250V~, Vidalı Bağlantı, NA Kontak, Yeşil Göstergeli, 1M	10	17,440 17,440 19,190	□ N4043N* ■ L4043N* ■ NT4043N*	 Işık Sembollü Liht Butonu, 10A, 250V~, Vidalı Bağlantı, NA Kontak, 1M	10	7,560 7,560 8,810
□ N4044N ■ L4044N ■ NT4044N	 İki Kutuplu Liht Butonu, 10A, 250V~, Vidalı Bağlantı, Bağımsız NA Kontak, 1M	10	9,970 9,970 10,950	□ N4043M2N* ■ L4043M2N* ■ NT4043M2N*	 Işık Sembollü Liht Butonu, 10A, 250V~, Vidalı Bağlantı, NA Kontak, 2M	10	8,520 8,520 9,840
				□ 26108N** ■ 26108L** ■ 26108T**	 IP55 Etiketli Liht Butonu, 10A, 250V~, Vidalı Bağlantı, 3M	1	60,140 60,140 60,140

\* LN4742V12T ve LN4742V230T referanslı LED lambalar ile donatılabilir.

\*\* Lamba ürüne dahildir.

REF.	TUŞ KAPAKLARI	AMB.	AD/€
□ N4916DP ■ L4916DP ■ NT4916DP	 Tuş Kapağı, 0.5M	10	4,980 4,980 5,860
□ N4916DPA ■ L4916DPA ■ NT4916DPA	 Ok Sembollü Tuş Kapağı, 0.5M	10	4,760 4,760 5,220

**PRİZLER**

REF.	ALMAN STANDARDI	AMB.	AD/€	REF.	İTALYAN STANDARDI	AMB.	AD/€
<input type="checkbox"/> N4141TR <input checked="" type="checkbox"/> L4141TR <input checked="" type="checkbox"/> NT4141TR	 Alman Standardı Topraklı Priz, 16A, 250V~, Vidalı Bağlantı, Çocuk Korumalı, 2M	10	11,580 11,580 12,730	<input type="checkbox"/> N4113 <input checked="" type="checkbox"/> L4113 <input checked="" type="checkbox"/> NT4113	 İtalyan Standardı Topraklı Priz, 10A, 250V~, Vidalı Bağlantı, Çocuk Korumalı, 1M	10	6,130 6,130 6,740
<input type="checkbox"/> N4141PW <input checked="" type="checkbox"/> L4141PW <input checked="" type="checkbox"/> NT4141PW	 Alman Standardı Kapaklı Topraklı Priz, 16A, 250V~, Vidalı Bağlantı, Çocuk Korumalı, 2M	5	19,580 19,580 21,530				
<input type="checkbox"/> N4141AN <input checked="" type="checkbox"/> L4141AN <input checked="" type="checkbox"/> NT4141AN	 Alman Standardı Topraklı Priz, 16A, 250V~, Otomatik Bağlantı, Çocuk Korumalı, 2M	10	10,350 10,350 11,390	<input type="checkbox"/> N4150 <input checked="" type="checkbox"/> L4150 <input checked="" type="checkbox"/> NT4150	 İngiliz Standardı Topraklı Priz, 13A, 250V~, Vidalı Bağlantı, 2M	10	26,690 26,690 29,370
<input type="radio"/> L4141R	 Alman Standardı Topraklı Priz, 16A, 250V~, Vidalı Bağlantı, Çocuk Korumalı, Kırmızı, 2M	10	10,750	<input type="checkbox"/> N4151 <input checked="" type="checkbox"/> NT4151	İngiliz Standardı Anahtarlı Topraklı Priz, 13A, 250V~, Vidalı Bağlantı, 2M	10	46,260 50,880
<input type="radio"/> L4141V	 Alman Standardı Topraklı Priz, 16A, 250V~, Vidalı Bağlantı, Çocuk Korumalı, Yeşil, 2M	10	10,750	<input type="checkbox"/> N4152 <input checked="" type="checkbox"/> NT4152	İkili İngiliz Standardı Anahtarlı Topraklı Priz, 13A, 250V~, Vidalı Bağlantı, 4M	5	71,050 78,160
REF.	FRANSIZ STANDARDI	AMB.	AD/€	REF.	TIRAŞ PRİZİ	AMB.	AD/€
<input type="checkbox"/> N4142 <input checked="" type="checkbox"/> L4142 <input checked="" type="checkbox"/> NT4142	 Fransız Standardı Topraklı Priz, 16A, 250V~, Vidalı Bağlantı, Çocuk Korumalı, 2M	10	12,100 12,100 13,310	<input type="checkbox"/> N4177* <input checked="" type="checkbox"/> L4177* <input checked="" type="checkbox"/> NT4177*	 Tıraş Prizi, 230V~, 20VA, 3M	1	116,030 116,030 136,750
<input type="checkbox"/> N4142AN <input checked="" type="checkbox"/> L4142AN <input checked="" type="checkbox"/> NT4142AN	 Fransız Standardı Topraklı Priz, 16A, 250V~, Otomatik Bağlantı, Çocuk Korumalı, 2M	10	11,640 11,640 12,810				
<input type="radio"/> L4142AR	 Fransız Standardı Topraklı Priz, 16A, 250V~, Vidalı Bağlantı, Çocuk Korumalı, Kırmızı, 2M	10	12,690				

\* Livinglight Air çerçeveler ile birlikte kullanırken kolay kablolama için buat genişletme aksesuarı kullanılması önerilir.

**Not:** Diğer uluslararası standartlara uygun prizler için satış ofisimize danışınız.

## TV PRİZLER

REF.	TV PRİZLERİ	AMB.	AD/€
<input type="checkbox"/> N4202DN	 TV Priz, Yıldız Bağlantı, 1M	1	16,480
<input type="checkbox"/> N4202M2DN	 TV Priz, Yıldız Bağlantı, 2M	1	31,670
<input type="checkbox"/> N4202P14N	 TV Priz, 14 dB, Geçişli, 1M	1	20,160
<input type="checkbox"/> N4202P10N	 TV Priz, 10 dB, Sonlu, 1M	1	19,330
<input type="checkbox"/> N4202FN	 TV Priz, F Tipi, 1M	1	14,820









REF.	TV / SAT PRİZLERİ	AMB.	AD/€
<input type="checkbox"/> N4214DN	 TV-SAT Priz, 1M	1	26,210
<input type="checkbox"/> N4214M2DN	 TV-SAT Priz, 2M	1	29,190

REF.	TV / R / SAT PRİZLERİ	AMB.	AD/€
<input type="checkbox"/> N4210M2DN	 TV-R-SAT Priz, 2M	1	46,740

REF.	TV PRİZ VE SOKETİ	AMB.	AD/€
<input type="checkbox"/> S2133	 Beyaz TV Fişi	12	4,960





REF.	SONLANDIRMA DİRENCİ	AMB.	AD/€
<input type="checkbox"/> 75RTN	 Sonlandırma Direnci, 75 Ohm	10	4,140

## DATA VE TELEFON PRİZLERİ







REF.	DATA PRİZLERİ	AMB.	AD/€
<input type="checkbox"/> N4279C5E	 Data Priz, CAT5e UTP, Aletsiz, 1M	10	14,940
<input checked="" type="checkbox"/> L4279C5E			14,940
<input checked="" type="checkbox"/> NT4279C5E			16,430
<input type="checkbox"/> N4279C5F	 Data Priz, CAT5e FTP, Aletsiz, 1M	10	24,550
<input checked="" type="checkbox"/> L4279C5F			24,550
<input checked="" type="checkbox"/> NT4279C5F			27,000
<input type="checkbox"/> N4279C6	 Data Priz, CAT6 UTP, Aletsiz, 1M	10	20,160
<input checked="" type="checkbox"/> L4279C6			20,160
<input checked="" type="checkbox"/> NT4279C6			22,180
<input type="checkbox"/> N4279C6F	 Data Priz, CAT6 FTP, Aletsiz, 1M	10	26,210
<input checked="" type="checkbox"/> L4279C6F			26,210
<input checked="" type="checkbox"/> NT4279C6F			28,840
<input type="checkbox"/> N4279C6S	 Data Priz, CAT6 STP, Aletsiz, 1M	1	25,860
<input checked="" type="checkbox"/> L4279C6S			25,860
<input checked="" type="checkbox"/> NT4279C6S			28,440
<input type="checkbox"/> N4279C6A	 Data Priz, CAT6A STP, Aletsiz, 1M	1	42,470
<input checked="" type="checkbox"/> L4279C6A			42,470
<input checked="" type="checkbox"/> NT4279C6A			46,720
<input type="checkbox"/> N4262C5E	 Data Priz, CAT5e UTP, 110 IDC, 1M	1	24,020
<input checked="" type="checkbox"/> L4262C5E			24,020
<input checked="" type="checkbox"/> NT4262C5E			26,410
<input type="checkbox"/> N4262C6	 Data Priz, CAT6 UTP, 110 IDC, 1M	1	27,620
<input checked="" type="checkbox"/> L4262C6			27,620
<input checked="" type="checkbox"/> NT4262C6			30,370
<input type="checkbox"/> N4262C6S	 Data Priz, CAT6 STP, 110 IDC, 1M	1	25,500
<input checked="" type="checkbox"/> L4262C6S			25,500
<input checked="" type="checkbox"/> NT4262C6S			28,040

REF.	TELEFON PRİZİ	AMB.	AD/€
<input type="checkbox"/> N4258/11N	 Telefon Priz, RJ11, 1M	1	18,020
<input checked="" type="checkbox"/> L4258/11N			18,020
<input checked="" type="checkbox"/> NT4258/11N			19,820





**ELEKTRONİK PRİZLER**

REF.	USB ŞARJ PRİZLERİ	AMB.	AD/€
□ N4191A ■ L4191A ■ NT4191A	 A Tipi USB Şarj Prizi, 3A, 100-240V~, 1M	1	34,080 34,080 37,500
□ N4192C ■ L4192C ■ NT4192C	 C Tipi USB Şarj Prizi, 3A, 100-240V~, 1M	1	48,680 48,680 53,540
□ N4191AC ■ L4191AC ■ NT4191AC	 A+C Tipi USB Şarj Prizi, 3A, 100-240V~, 1M	1	66,430 66,430 73,080
□ N4191AA ■ L4191AA ■ NT4191AA	 A+A Tipi USB Şarj Prizi, 3A, 100-240V~, 1M	1	53,980 53,980 59,370
□ N4191CC ■ L4191CC ■ NT4191CC	 C+C Tipi USB Şarj Prizi, 3A, 100-240V~, 1M	1	78,770 78,770 86,650

**AUDIO VIDEO PRİZLER**





REF.	AUDIO VIDEO PRİZLER	AMB.	AD/€
□ N4269R ■ L4269R ■ NT4269R	 İki RCA Konnektör, Kaynak İle Bağlantı, Sarı - Kırmızı Kontak, 1M	1	28,220 28,220 31,060
□ N4294 ■ L4294 ■ NT4294	 Hoparlör Konnektörü, 1M	1	26,570 26,570 29,230
□ N4280 ■ L4280 ■ NT4280	 3.5 mm Jack Konnektörü, 1M	1	26,570 26,570 29,230
□ N4281 ■ L4281 ■ NT4281	 İki RCA Konnektör, Beyaz - Kırmızı Kontak, 1M	1	35,710 35,710 39,270
□ N4284 ■ L4284 ■ NT4284	 Önceden sonlandırılmış HDMI Konnektör, 2M	1	42,470 42,470 46,720
□ N4285 ■ L4285 ■ NT4285	 USB Data Prizi, 1M	1	34,280 34,280 37,700

**DİMMERLER**

REF.	ROTATİF DİMMERLER	AMB.	AD/€	REF.	DOKUNMATİK DİMMERLER	AMB.	AD/€
□ N4402N* ■ L4402N* ■ NT4402N*	 Vavien Rotatif Dimmer, 230V~, 60-500W, 1M	1	63,290 63,290 69,620	□ N4410N ■ L4410N ■ NT4410N	 0-10V Dokunmatik Dimmer, 240V~, 300-600W, 2M	1	130,750 130,750 142,400
□ N4406* ■ L4406* ■ NT4406*	 Rotatif Dimmer, 230V~, 100-500W, 1M	1	43,880 43,880 48,280	□ N4582N ■ L4582N ■ NT4582N	 Dokunmatik Dimmer, 240V~, 400-700W, 2M	1	100,000 100,000 110,010
□ N4581 ■ L4581 ■ NT4581	 Rotatif Dimmer, 230V~, 400/800W, 1M	1	80,080 80,080 88,090				





\* AIR Çerçeveler ile birlikte kullanımda estetik bir görünüm için dokunmatik dimmer veya universal dimmer kullanımı önerilir. Eğer rotatif dimmer kurulumu yapılıyorsa, kolay kablolama için buat genişletme aksesuarı kullanılması önerilir.

## HAREKET SENSÖRLERİ

REF.	HAREKET SENSÖRLERİ	AMB.	AD/€
<input type="checkbox"/> N4433N <input checked="" type="checkbox"/> L4433N <input checked="" type="checkbox"/> NT4433N	 Dual Sensörlü (PIR + Ultrasonik) Hareket Sensörü, 2.5A, 230V~, 2000W, 8m, 2M	1	191,240 191,240 210,360
<input type="checkbox"/> N4434N <input checked="" type="checkbox"/> L4434N <input checked="" type="checkbox"/> NT4434N	 PIR Hareket Sensörü, 1.7A, 230V~, 400W, 8m, 2M	1	191,240 191,240 210,360
<input type="checkbox"/> N4431N <input checked="" type="checkbox"/> L4431N <input checked="" type="checkbox"/> NT4431N	 PIR Hareket Sensörü, 2A, 230V~, 200W, 6m, 105°, 1M	1	121,830 121,830 134,020
<input type="checkbox"/> N4003ES <input checked="" type="checkbox"/> L4003ES <input checked="" type="checkbox"/> NT4003ES	 PIR Hareket Sensörü, 230V~, 150W, 8m, 160°, Nötrsüz, 2M	1	83,280 83,280 91,620

**Not:** Hareket sensörü seçimi konusunda ayrıntılı bilgi için ürün kataloğunu inceleyiniz.

## TERMOSTATLAR

REF.	TERMOSTATLAR	AMB.	AD/€
<input type="checkbox"/> N4441 <input checked="" type="checkbox"/> L4441 <input checked="" type="checkbox"/> NT4441	 Elektronik Ortam Termostatı, 2A, 250V~, 2M	1	149,830 149,830 164,820
<input type="checkbox"/> N4441FH <input checked="" type="checkbox"/> L4441FH <input checked="" type="checkbox"/> NT4441FH	 Elektronik Ortam Termostatı, 2A, 250V~, Harici Sensör Bağlantılı, 2M	1	155,330 155,330 170,860
<input type="checkbox"/> N4442 <input checked="" type="checkbox"/> L4442 <input checked="" type="checkbox"/> NT4442	 Elektronik Ortam Termostatı, 2A, 250V~, Yaz/Kış Seçimli, 2M	1	158,850 158,850 174,740
<input type="checkbox"/> N4451 <input checked="" type="checkbox"/> L4451 <input checked="" type="checkbox"/> NT4451	 Programlanabilir Ortam Termostatı, Pili, Harici Sensör Bağlantılı, 3M	1	306,910 306,910 337,600

## OTEL ÇÖZÜMLERİ

REF.	ENERGY SAVER	AMB.	AD/€
<input type="radio"/> LN4549	 Mekanik Anahtarlı Energy Saver, 230V~, 2M	1	112,350

<input type="radio"/> LN4548	 RFID Energy Saver, 230V~, 2M	1	158,850
------------------------------	--	---	---------

REF.	ENERGY SAVER TUŞ KAPAKLARI	AMB.	AD/€
<input type="checkbox"/> N4547 <input checked="" type="checkbox"/> L4547 <input checked="" type="checkbox"/> NT4547	 Energy Saver Ürünleri İçin Kapak, 2M	1	25,020 25,020 27,530

<input type="checkbox"/> N4551 <input checked="" type="checkbox"/> L4551 <input checked="" type="checkbox"/> NT4551	 Energy Saver Ürünleri İçin Kapak, 3M	1	31,670 31,670 34,830
---	--	---	----------------------------

REF.	DİMLENEBİLİR OKUMA LAMBASI	AMB.	AD/€
<input type="checkbox"/> N4362 <input checked="" type="checkbox"/> L4362 <input checked="" type="checkbox"/> NT4362	 Dimlenebilir Okuma Lambası, 1M	1	191,240 191,240 210,360

REF.	OTEL ÇAĞRI ÜNİTELERİ	AMB.	AD/€
<input type="checkbox"/> N4373H <input checked="" type="checkbox"/> L4373H <input checked="" type="checkbox"/> NT4373H	 Otel Çağrı Göstergesi, 1M	10	25,020 25,020 27,530

<input type="checkbox"/> N4028HN <input checked="" type="checkbox"/> L4028HN	 Otel Çağrı Butonu, 16A, 250V~, DND/MUR Sembollü, 1M	10	15,550 15,550
---	---	----	------------------

\* Farklı energy saver çözümlerimiz için satış ofisimize danışınız.



REF.	TUŞ KAPAKLARI	AMB.	AD/€
<input type="checkbox"/> N4915DD <input checked="" type="checkbox"/> L4915DD <input checked="" type="checkbox"/> NT4915DD	 DND Sembollü Tuş Kapağı, 1M	10	10,170



<input type="checkbox"/> N4915MR <input checked="" type="checkbox"/> L4915MR <input checked="" type="checkbox"/> NT4915MR	 MUR Sembollü Tuş Kapağı, 1M	10	10,170
---	---	----	--------

<input type="checkbox"/> N4915M2DD <input checked="" type="checkbox"/> L4915M2DD <input checked="" type="checkbox"/> NT4915M2DD	 DND Sembollü Tuş Kapağı, 2M	10	11,560 11,560 12,710
---	---	----	----------------------------

<input type="checkbox"/> N4915TN <input checked="" type="checkbox"/> L4915TN <input checked="" type="checkbox"/> NT4915TN	 Kişiselleştirilebilir Tuş Kapağı, 1M	10	6,680 6,680 7,350
---	--	----	-------------------------







**İKAZ VE SİNYAL MEKANİZMALARI**



REF.	ZİLLER	AMB.	AD/€
□ N4351/12 ■ L4351/12 ■ NT4351/12	 Zil, 12V~, 5VA, 80 dB, 1M	10	24,320 24,320 26,750
□ N4351/230 ■ L4351/230 ■ NT4351/230	 Zil, 230V~, 8VA, 80 dB, 1M	10	30,360 30,360 33,400
□ N4355/12 ■ L4355/12 ■ NT4355/12	 Elektronik Zil, 12V~/12VDC, 2M	1	79,720 79,720 87,700



REF.	BUZZER	AMB.	AD/€
□ N4356/12 ■ L4356/12 ■ NT4356/12	 Buzzer, 12V~, 5VA, 74 dB, 1M	10	16,830 16,830 18,520
□ N4356/230 ■ L4356/230 ■ NT4356/230	 Buzzer, 230V~, 8VA, 75 dB, 1M	10	22,180 22,180 24,400

REF.	KILAVUZ LAMBALARI	AMB.	AD/€
□ N4371T* ■ L4371T* ■ NT4371T*	 Transparan Gösterge Lambası, 1M	10	10,710 10,710 11,780
□ N4371R* ■ L4371R* ■ NT4371R*	 Kırmızı Gösterge Lambası, 1M	10	10,710 10,710 11,780
□ N4371V* ■ L4371V* ■ NT4371V*	 Yeşil Gösterge Lambası, 1M	10	10,710 10,710 11,780
□ N4372AV* ■ L4372AV* ■ NT4372AV*	 Turuncu ve Yeşil Gösterge Lambası, 1M	10	15,050 15,050 16,560

\* LN4742V12T ve LN4742V230T ile donatılabilir.



REF.	SİNYAL MEKANİZMALARI	AMB.	AD/€
■ L4385/12R ■ L4385/12V ■ L4385/12B	 Sinyalizasyon Lambası, 12V~, 1M	1	32,740
■ L4385/24R ■ L4385/24V ■ L4385/24B	 Sinyalizasyon Lambası, 24V~, 1M	1	32,390
■ L4385/230R ■ L4385/230V ■ L4385/230B	 Sinyalizasyon Lambası, 230V~, 1M	1	35,110
○ L4745/12	 Lamba, 12V~, 5W, E10	10	12,810
○ L4745/24	 Lamba, 24V~, 5W, E10	10	12,810
○ L4745/230	 Lamba, 230V~, 5W, E10	10	12,810

REF.	SİNYAL LAMBALARI	AMB.	AD/€
○ L4374V12V24	 Sinyal Lambası, 12/24V~, 2M	10	38,550
○ L4374/230	 Sinyal Lambası, 230V~, 2M	10	35,110

REF.	MERDİVEN BASAMAĞI LAMB.	AMB.	AD/€
○ L4382V12V24	 Merdiven Basamağı Aydınlatması, 12/24V~, 2M	10	33,920
○ L4382/230	 Merdiven Basamağı Aydınlatması, 230V~, 2M	10	33,920





REF.	360° ODAKLI LAMBA	AMB.	AD/€
○ LN4360	 360° Odaklı Lamba, 2M	1	83,280

REF.	YÖNLÜ ZEMİN LAMBASI	AMB.	AD/€
○ LN4361	 Yönlü Zemin Lambası, 2M	1	107,960

REF.	TAŞINABİLİR LAMBA	AMB.	AD/€
○ LN4380N	 Taşınabilir Lamba, 230V~, 2M	1	59,550
○ 4380NB	 LN4380N İçin Batarya	1	14,110

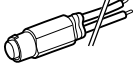
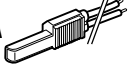
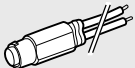
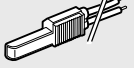
REF.	ACİL DURUM LAMBASI	AMB.	AD/€
○ L4384/1	 Acil Durum Aydınlatma Lambası, 230V~, 4M	1	197,410
○ L4386/1	 Acil Durum Aydınlatma Lambası, 230V~, 6M	1	208,200
○ L4784/1	 L4384/1 İçin Batarya	1	33,940
○ L4786/1	 L4384/1 İçin Batarya	3	44,990

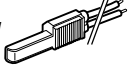
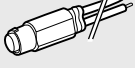
## LED LAMBALAR

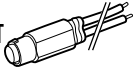
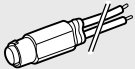
REF.	STANDART ANAHTARLAR İÇİN	AMB.	AD/€	REF.	AXIAL ANAHTARLAR İÇİN	AMB.	AD/€
○ LN4742V230	 LED Lamba, 230V~, Kehribar	100	3,730	○ LN4743/230A	 LED Lamba, 230V~, Kehribar	10	3,730
○ LN4742V12	 LED Lamba, 12/24V~, Kehribar	100	3,730	○ LN4743/12A	 LED Lamba, 12/24V~, Kehribar	10	3,730
○ LN4742V230V	 LED Lamba, 230V~, Yeşil	100	3,730	○ LN4743/230V	 LED Lamba, 230V~, Yeşil	10	3,730
○ LN4742V12V	 LED Lamba, 12/24V~, Yeşil	100	4,390	○ LN4743/12V	 LED Lamba, 12/24V~, Yeşil	10	3,730
○ LN4742V230T	 Pilot Lamba, 230V~, Beyaz	100	4,100	○ LN4743/230T	LED Lamba, 230V~, Beyaz	10	4,190
○ LN4742V12T	 Pilot Lamba, 12V~, Beyaz	100	4,100	○ LN4743/12T	LED Lamba, 12/24V~, Beyaz	10	4,190
				○ H4743/230B	LED Lamba, 230V~, Mavi	10	4,100
				○ H4743/12B	LED Lamba, 12V~, Mavi	10	4,100

\* LED lamba seçimi konusunda ayrıntılı bilgi için ürün kataloğunu inceleyiniz.

## BOŞLUK KAPAKLARI

REF.	BOŞLUK KAPAKLARI	AMB.	AD/€
□ N4950 ■ L4950 ■ NT4950	 Boşluk Kapağı, 1M	10	1,220 1,220 1,750
□ N4951 ■ L4951 ■ NT4951	 Kırılabilir Bölmeli Boşluk Kapağı, 2M	5	2,150 2,150 3,460
□ N4953 ■ L4953 ■ NT4953	 Kablo Çıkış Kapağı, 1M	10	5,860 5,860 6,440
□ N4954 ■ L4954 ■ NT4954	 Kablo Çıkış Kapağı, 2M	10	18,500 18,500 22,010

**STANDART ANAHTAR TUŞ KAPAKLARI**

N4915N



NT4915N



L4915N



N4915LN

REF.	TUŞ KAPAKLARI	AMB.	AD/€	REF.	TUŞ KAPAKLARI	AMB.	AD/€	REF.	TUŞ KAPAKLARI	AMB.	AD/€
<input type="checkbox"/> N4915N <input checked="" type="checkbox"/> L4915N <input checked="" type="checkbox"/> NT4915N	Sembolsüz Tuş Kapağı, 1M	10	4,980 4,980 6,040	<input type="checkbox"/> N4915M2N <input checked="" type="checkbox"/> L4915M2N <input checked="" type="checkbox"/> NT4915M2N	Sembolsüz Tuş Kapağı, 2M	10	6,170 6,170 7,120	<input type="checkbox"/> N4915M3N <input checked="" type="checkbox"/> L4915M3N <input checked="" type="checkbox"/> NT4915M3N	Sembolsüz Tuş Kapağı, 3M	10	9,020 9,020 9,910
<input type="checkbox"/> N4915LN	Sembolsüz Tuş Kapağı, Yüksek Parlaklığı, 1M	10	7,110	<input type="checkbox"/> N4915M2LN	Sembolsüz Tuş Kapağı, Yüksek Parlaklığı, 2M	10	10,670	<input type="checkbox"/> N4915M3LN	Sembolsüz Tuş Kapağı, Yüksek Parlaklığı, 3M	10	10,670



NT4915AN



NT4915BN



NT4915DN



NT4915FN



NT4915M2ADN



NT4915DD



NT4915MR

REF.	SEMBOLLÜ TUŞ KAPAKLARI	AMB.	AD/€	REF.	SEMBOLLÜ TUŞ KAPAKLARI	AMB.	AD/€
<input type="checkbox"/> N4915AN <input checked="" type="checkbox"/> L4915AN <input checked="" type="checkbox"/> NT4915AN	Işık Sembollü Tuş Kapağı, 1M	10	10,170	<input type="checkbox"/> N4915M2AN <input checked="" type="checkbox"/> L4915M2AN <input checked="" type="checkbox"/> NT4915M2AN	Işık Sembollü Tuş Kapağı, 2M	10	11,560 11,560 12,710
<input type="checkbox"/> N4915BN <input checked="" type="checkbox"/> L4915BN <input checked="" type="checkbox"/> NT4915BN	Merdiven Aydınlatması Sembollü Tuş Kapağı, 1M	10	10,170	<input type="checkbox"/> N4915M2BN <input checked="" type="checkbox"/> L4915M2BN <input checked="" type="checkbox"/> NT4915M2BN	Merdiven Aydınlatması Sembollü Tuş Kapağı, 2M	10	11,560 11,560 12,710
<input type="checkbox"/> N4915DN <input checked="" type="checkbox"/> L4915DN <input checked="" type="checkbox"/> NT4915DN	Zil Sembollü Tuş Kapağı, 1M	10	10,170	<input type="checkbox"/> N4915M2DN <input checked="" type="checkbox"/> L4915M2DN <input checked="" type="checkbox"/> NT4915M2DN	Zil Sembollü Tuş Kapağı, 2M	10	11,560 11,560 12,710
<input type="checkbox"/> N4915FN <input checked="" type="checkbox"/> L4915FN <input checked="" type="checkbox"/> NT4915FN	Anahtar Sembollü Tuş Kapağı, 1M	10	10,170	<input type="checkbox"/> N4915M2FN <input checked="" type="checkbox"/> L4915M2FN <input checked="" type="checkbox"/> NT4915M2FN	Anahtar Sembollü Tuş Kapağı, 2M	10	11,560 11,560 12,710
<input type="checkbox"/> N4915DD <input checked="" type="checkbox"/> L4915DD <input checked="" type="checkbox"/> NT4915DD	DND Sembollü Tuş Kapağı, 1M	10	10,170	<input type="checkbox"/> N4915M2ADN <input checked="" type="checkbox"/> L4915M2ADN <input checked="" type="checkbox"/> NT4915M2ADN	Dimmer Sembollü Tuş Kapağı, 2M	10	11,560 11,560 12,710
<input type="checkbox"/> N4915MR <input checked="" type="checkbox"/> L4915MR <input checked="" type="checkbox"/> NT4915MR	MUR Sembollü Tuş Kapağı, 1M	10	10,170	<input type="checkbox"/> N4915M2DD <input checked="" type="checkbox"/> L4915M2DD <input checked="" type="checkbox"/> NT4915M2DD	DND Sembollü Tuş Kapağı, 2M	10	11,560 11,560 12,710

## AXIAL ANAHTAR TUŞ KAPAKLARI



NT4916

REF.	SEMBOLSÜZ TUŞ KAPAKLARI	AMB.	AD/€	REF.	SEMBOLSÜZ TUŞ KAPAKLARI	AMB.	AD/€
<input type="checkbox"/> N4916	Sembolsüz Tuş Kapağı, 1M	10	4,980	<input type="checkbox"/> N4916M2	Işık Sembollü Tuş Kapağı, 2M	10	6,530
<input checked="" type="checkbox"/> L4916			4,980	<input checked="" type="checkbox"/> L4916M2			6,530
<input checked="" type="checkbox"/> NT4916			6,040	<input checked="" type="checkbox"/> NT4916M2			6,630



NT4916A



NT4916B



NT4916D



NT4916F

REF.	SEMBOLLÜ TUŞ KAPAKLARI	AMB.	AD/€	REF.	SEMBOLLÜ TUŞ KAPAKLARI	AMB.	AD/€
<input type="checkbox"/> N4916A	Işık Sembollü Tuş Kapağı, 1M	10	10,170	<input type="checkbox"/> N4916M2A	Işık Sembollü Tuş Kapağı, 2M	10	11,560
<input checked="" type="checkbox"/> L4916A			10,170	<input checked="" type="checkbox"/> L4916M2A			11,560
<input checked="" type="checkbox"/> NT4916A			12,710	<input checked="" type="checkbox"/> NT4916M2A			12,710
<input type="checkbox"/> N4916B	Merdiven Aydınlatması Sembollü Tuş Kapağı, 1M	10	10,170	<input type="checkbox"/> N4916M2B	Merdiven Aydınlatması Sembollü Tuş Kapağı, 2M	10	11,560
<input checked="" type="checkbox"/> L4916B			10,170	<input checked="" type="checkbox"/> L4916M2B			11,560
<input checked="" type="checkbox"/> NT4916B			12,710	<input checked="" type="checkbox"/> NT4916M2B			12,710
<input type="checkbox"/> N4916D	Zil Sembollü Tuş Kapağı, 1M	10	10,170	<input type="checkbox"/> N4916M2D	Zil Sembollü Tuş Kapağı, 2M	10	11,560
<input checked="" type="checkbox"/> L4916D			10,170	<input checked="" type="checkbox"/> L4916M2D			11,560
<input checked="" type="checkbox"/> NT4916D			12,710	<input checked="" type="checkbox"/> NT4916M2D			12,710
<input type="checkbox"/> N4916F	Anahtar Sembollü Tuş Kapağı, 1M	10	10,170	<input type="checkbox"/> N4916M2F	Anahtar Sembollü Tuş Kapağı, 2M	10	11,560
<input checked="" type="checkbox"/> L4916F			10,170	<input checked="" type="checkbox"/> L4916M2F			11,560
<input checked="" type="checkbox"/> NT4916F			12,710	<input checked="" type="checkbox"/> NT4916M2F			12,710



NT4916T





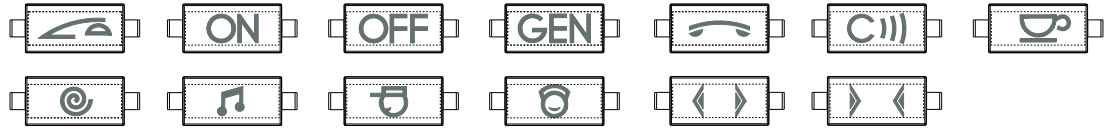











NT4916M2T

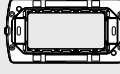

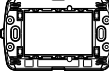
REF.	KİŞİSELLEŞTİRİLEBİLİR TUŞ KPK.	AMB.	AD/€	REF.	KİŞİSELLEŞTİRİLEBİLİR TUŞ KPK.	AMB.	AD/€
<input type="checkbox"/> N4916T	Kişiselleştirilebilir Tuş Kapağı, 1M	10	6,170	<input type="checkbox"/> N4916M2T	Kişiselleştirilebilir Tuş Kapağı, 2M	10	6,170
<input checked="" type="checkbox"/> L4916T			6,170	<input checked="" type="checkbox"/> L4916M2T			6,170
<input checked="" type="checkbox"/> NT4916T			6,780	<input checked="" type="checkbox"/> NT4916M2T			6,780

**KAİDELER**

REF.	PLASTİK KAİDELER	AMB.	AD/€	REF.	GEÇMELİ UYGULAMA - AIR İÇİN	AMB.	AD/€
○ LN4702G	 Plastik Kaide, Tırnaklı, 2M	100	3,440	○ LN4702E	 Living Light Air LNE... Serisi Çerçeve İçin Kaide, Plastik, 2M	10	6,530
○ LN4702	 Plastik Kaide, Vidalı, 2M	100	1,790				
REF.	METAL KAİDELER	AMB.	AD/€	REF.	MODÜLER UYGULAMA - AIR İÇİN	AMB.	AD/€
○ LN4702MG	 Metal Kaide, Tırnaklı, 2M	100	7,110	○ LN4702E	 Living Light Air LNE... Serisi Çerçeve İçin Kaide, Plastik, 2M	10	6,530
○ LN4702M	 Metal Kaide, Vidalı, 2M	100	3,040	○ LN4702C	 Living Light Air LNC... Serisi Çerçeve İçin Kaide, Plastik, 2M	10	2,110
REF.	MODÜLER UYGULAMA İÇİN	AMB.	AD/€	○ LN4703C	 Living Light Air LNC... Serisi Çerçeve İçin Kaide, Plastik, 3M	20	2,110
○ L4702G	 Living Light International Çerçeve için Plastik Kaide, Tırnaklı, 2M	100	5,920	○ LN4704C	 Living Light Air LNC... Serisi Çerçeve İçin Kaide, Plastik, 4M	10	3,820
○ L4702	 Living Light International Çerçeve için Plastik Kaide, Vidalı, 2M	100	1,810	○ LN4707C	 Living Light Air LNC... Serisi Çerçeve İçin Kaide, Plastik, 7M	10	7,280
○ LN4703	 Living Light ve Living Light International Çerçeve İçin Plastik Kaide, Vidalı, 3M	10	1,790	○ LN4726C	 Living Light Air LNC... Serisi Çerçeve İçin Kaide, Plastik, 3+3M	10	8,440
○ LN4704	 Living Light ve Living Light International Çerçeve İçin Plastik Kaide, Vidalı, 4M	10	3,440				
○ LN4707	 Living Light ve Living Light International Çerçeve İçin Plastik Kaide, Vidalı, 7M	50	6,360				
○ LN4726	 Living Light ve Living Light International Çerçeve İçin Plastik Kaide, Vidalı, 3+3M	20	5,920				

## POLİMER PLASTİK ÇERÇEVELER

REF.	POLİMER PLASTİK ÇERÇEVELER	AMB.	AD/€	REF.	POLİMER PLASTİK ÇERÇEVELER	AMB.	AD/€
LNA4802BI	Çerçeve, Beyaz, 2M	1	3,920	LNA4802KG	Çerçeve, Buz, 2M	1	9,030
LNA4803BI	Çerçeve, Beyaz, 3M	1	3,920	LNA4803KG	Çerçeve, Buz, 3M	1	9,030
LNA4804BI	Çerçeve, Beyaz, 4M	1	5,910	LNA4804KG	Çerçeve, Buz, 4M	1	13,350
LNA4807BI	Çerçeve, Beyaz, 7M	1	8,580	LNA4807KG	Çerçeve, Buz, 7M	1	22,870
LNA4802M2BI	Çerçeve, Beyaz, 2+2M	1	6,990	LNA4802M2KG	Çerçeve, Buz, 2+2M	1	16,460
LNA4802M3BI	Çerçeve, Beyaz, 2+2+2M	1	11,270	LNA4802M3KG	Çerçeve, Buz, 2+2+2M	1	24,450
LNA4802M4BI	Çerçeve, Beyaz, 2+2+2+2M	1	13,530	LNA4802M4KG	Çerçeve, Buz, 2+2+2+2M	1	31,580
LNA4826BI	Çerçeve, Beyaz, 3+3M	1	9,030	LNA4826KG	Çerçeve, Buz, 3+3M	1	22,550
LNA4802AR	Çerçeve, Antrasit, 2M	1	3,920				
LNA4803AR	Çerçeve, Antrasit, 3M	1	3,920				
LNA4804AR	Çerçeve, Antrasit, 4M	1	5,910				
LNA4807AR	Çerçeve, Antrasit, 7M	1	8,580				
LNA4802M2AR	Çerçeve, Antrasit, 2+2M	1	6,990				
LNA4802M3AR	Çerçeve, Antrasit, 2+2+2M	1	11,270				
LNA4802M4AR	Çerçeve, Antrasit, 2+2+2+2M	1	13,530				
LNA4826AR	Çerçeve, Antrasit, 3+3M	1	9,030				
LNA4802TE	Çerçeve, Alüminyum, 2M	1	6,740				
LNA4803TE	Çerçeve, Alüminyum, 3M	1	6,740				
LNA4804TE	Çerçeve, Alüminyum, 4M	1	10,480				
LNA4807TE	Çerçeve, Alüminyum, 7M	1	14,590				
LNA4802M2TE	Çerçeve, Alüminyum, 2+2M	1	13,070				
LNA4802M3TE	Çerçeve, Alüminyum, 2+2+2M	1	17,720				
LNA4802M4TE	Çerçeve, Alüminyum, 2+2+2+2M	1	23,490				
LNA4826TE	Çerçeve, Alüminyum, 3+3M	1	20,310				
LNA4802KF	Çerçeve, Sis, 2M	1	9,030				
LNA4803KF	Çerçeve, Sis, 3M	1	9,350				
LNA4804KF	Çerçeve, Sis, 4M	1	13,350				
LNA4807KF	Çerçeve, Sis, 7M	1	22,870				
LNA4802M2KF	Çerçeve, Sis, 2+2M	1	16,460				
LNA4802M3KF	Çerçeve, Sis, 2+2+2M	1	24,450				
LNA4802M4KF	Çerçeve, Sis, 2+2+2+2M	1	31,580				
LNA4826KF	Çerçeve, Sis, 3+3M	1	22,550				
LNA4802KA	Çerçeve, Akvamarin, 2M	1	9,030				
LNA4803KA	Çerçeve, Akvamarin, 3M	1	9,030				
LNA4804KA	Çerçeve, Akvamarin, 4M	1	13,350				
LNA4807KA	Çerçeve, Akvamarin, 7M	1	22,870				
LNA4802M2KA	Çerçeve, Akvamarin, 2+2M	1	16,460				
LNA4802M3KA	Çerçeve, Akvamarin, 2+2+2M	1	24,450				
LNA4802M4KA	Çerçeve, Akvamarin, 2+2+2+2M	1	31,580				
LNA4826KA	Çerçeve, Akvamarin, 3+3M	1	22,550				

**METAL ÇERÇEVELER**

REF.	METAL ÇERÇEVELER	AMB.	AD/€
LNA4802AE	Çerçeve, Kum, 2M	1	17,320
LNA4803AE	Çerçeve, Kum, 3M	1	17,320
LNA4804AE	Çerçeve, Kum, 7M	1	24,200
LNA4807AE	Çerçeve, Kum, 7M	1	37,490
LNA4802M2AE	Çerçeve, Kum, 2+2M	1	54,140
LNA4802M3AE	Çerçeve, Kum, 2+2+2M	1	58,650
LNA4802M4AE	Çerçeve, Kum, 2+2+2+2M	1	85,720
LNA4826AE	Çerçeve, Kum, 3+3M	1	55,230
LNA4802SQ	Çerçeve, Toprak, 2M	1	17,320
LNA4803SQ	Çerçeve, Toprak, 3M	1	17,320
LNA4804SQ	Çerçeve, Toprak, 7M	1	24,200
LNA4807SQ	Çerçeve, Toprak, 7M	1	37,490
LNA4802M2SQ	Çerçeve, Toprak, 2+2M	1	54,140
LNA4802M3SQ	Çerçeve, Toprak, 2+2+2M	1	58,650
LNA4802M4SQ	Çerçeve, Toprak, 2+2+2+2M	1	85,720
LNA4826SQ	Çerçeve, Toprak, 3+3M	1	55,230
LNA4802AG	Çerçeve, Gümüş, 2M	1	20,520
LNA4803AG	Çerçeve, Gümüş, 3M	1	20,520
LNA4804AG	Çerçeve, Gümüş, 4M	1	29,890
LNA4807AG	Çerçeve, Gümüş, 7M	1	45,080
LNA4802M2AG	Çerçeve, Gümüş, 2+2M	1	59,100
LNA4802M3AG	Çerçeve, Gümüş, 2+2+2M	1	62,720
LNA4802M4AG	Çerçeve, Gümüş, 2+2+2+2M	1	94,750
LNA4826AG	Çerçeve, Gümüş, 3+3M	1	56,310

**LIVING INTERNATIONAL ÇERÇEVELER**

REF.	ELİPTİK ÇERÇEVELER	AMB.	AD/€
L4802PB	Çerçeve, Beyaz, 2M	1	5,210
L4803PB	Çerçeve, Beyaz, 3M	1	5,210
L4804PB	Çerçeve, Beyaz, 4M	1	7,590
L4807PB	Çerçeve, Beyaz, 7M	1	11,270
L4802PA	Çerçeve, Koyu Çelik, 2M	1	5,210
L4803PA	Çerçeve, Koyu Çelik, 3M	1	5,210
L4804PA	Çerçeve, Koyu Çelik, 4M	1	7,590
L4807PA	Çerçeve, Koyu Çelik, 7M	1	11,270
L4802BI	Çerçeve, Tam Beyaz, 2M	1	16,600
L4803BI	Çerçeve, Tam Beyaz, 3M	1	16,600
L4804BI	Çerçeve, Tam Beyaz, 4M	1	24,200
L4807BI	Çerçeve, Tam Beyaz, 7M	1	35,950
L4802GF	Çerçeve, Grafit, 2M	5	21,080
L4803GF	Çerçeve, Grafit, 3M	10	21,080
L4804GF	Çerçeve, Grafit, 4M	5	30,480
L4807GF	Çerçeve, Grafit, 7M	1	45,950
L4826GF	Çerçeve, Grafit, 3+3M	1	67,670
L4802GFN	Çerçeve, Siyah Grafit, 2M	1	21,080
L4803GFN	Çerçeve, Siyah Grafit, 3M	1	21,080
L4804GFN	Çerçeve, Siyah Grafit, 4M	1	30,480
L4807GFN	Çerçeve, Siyah Grafit, 7M	1	45,950
L4826GFN	Çerçeve, Siyah Grafit, 3+3M	1	67,670
L4802TE	Çerçeve, Alüminyum, 2M	1	21,820
L4803TE	Çerçeve, Alüminyum, 3M	10	21,820
L4804TE	Çerçeve, Alüminyum, 4M	1	31,550
L4807TE	Çerçeve, Alüminyum, 7M	1	47,570
L4802AL	Çerçeve, Alüminyum, 2M	5	35,520
L4803AL	Çerçeve, Alüminyum, 3M	10	35,520
L4804AL	Çerçeve, Alüminyum, 4M	5	51,330
L4807AL	Çerçeve, Alüminyum, 7M	1	78,040
L4826AL	Çerçeve, Alüminyum, 3+3M	1	104,160
L4802AC	Çerçeve, Koyu Çelik, 2M	5	35,520
L4803AC	Çerçeve, Koyu Çelik, 3M	10	35,520
L4804AC	Çerçeve, Koyu Çelik, 4M	5	51,330
L4807AC	Çerçeve, Koyu Çelik, 7M	1	78,040
L4826AC	Çerçeve, Koyu Çelik, 3+3M	1	104,160

## AIR ÇERÇEVELER

REF.	MODÜLER SİSTEM İÇİN	AMB.	AD/€
LNC4803TE	Çerçeve, Alüminyum, 3M	1	20,970
LNC4804TE	Çerçeve, Alüminyum, 4M	1	23,960
LNC4826TE	Çerçeve, Alüminyum, 3+3M	1	35,470
LNC4807TE	Çerçeve, Alüminyum, 7M	1	35,830
LNC4803ST	Çerçeve, Füme, 3M	1	20,970
LNC4804ST	Çerçeve, Füme, 4M	1	23,960
LNC4826ST	Çerçeve, Füme, 3+3M	1	35,470
LNC4807ST	Çerçeve, Füme, 7M	1	35,830
LNC4803CY	Çerçeve, Toprak, 3M	1	20,970
LNC4804CY	Çerçeve, Toprak, 4M	1	23,960
LNC4826CY	Çerçeve, Toprak, 3+3M	1	35,470
LNC4807CY	Çerçeve, Toprak, 7M	1	35,830
LNC4803BM	Çerçeve, Mavi Ay, 3M	1	20,970
LNC4804BM	Çerçeve, Mavi Ay, 4M	1	23,960
LNC4826BM	Çerçeve, Mavi Ay, 3+3M	1	35,470
LNC4807BM	Çerçeve, Mavi Ay, 7M	1	35,830
LNC4803BN	Çerçeve, Beyaz, 3M	1	21,710
LNC4804BN	Çerçeve, Beyaz, 4M	1	23,960
LNC4826BN	Çerçeve, Beyaz, 3+3M	1	35,470
LNC4807BN	Çerçeve, Beyaz, 7M	1	35,830
LNC4803AR	Çerçeve, Antrasit, 3M	1	21,710
LNC4804AR	Çerçeve, Antrasit, 4M	1	23,960
LNC4826AR	Çerçeve, Antrasit, 3+3M	1	35,470
LNC4807AR	Çerçeve, Antrasit, 7M	1	35,830
LNC4803SB	Çerçeve, Kum, 3M	1	21,710
LNC4804SB	Çerçeve, Kum, 4M	1	23,960
LNC4826SB	Çerçeve, Kum, 3+3M	1	35,470
LNC4807SB	Çerçeve, Kum, 7M	1	35,830
LNC4803PR	Çerçeve, İnci Beyazı, 3M	1	27,410
LNC4804PR	Çerçeve, İnci Beyazı, 4M	1	39,970
LNC4826PR	Çerçeve, İnci Beyazı, 3+3M	1	54,920
LNC4807PR	Çerçeve, İnci Beyazı, 7M	1	60,500

## AIR ÇERÇEVELER

REF.	GEÇMELİ SİSTEM İÇİN	AMB.	AD/€
LNE4802BN	Çerçeve, Beyaz, 2M	1	23,280
LNE4802M2BN	Çerçeve, Beyaz, 2+2M	1	35,830
LNE4802M3BN	Çerçeve, Beyaz, 2+2+2M	1	48,750
LNE4802TE	Çerçeve, Alüminyum, 2M	1	23,280
LNE4802M2TE	Çerçeve, Alüminyum, 2+2M	1	35,830
LNE4802M3TE	Çerçeve, Alüminyum, 2+2+2M	1	48,750

**BAĞLI AYDINLATMA KONTROL CİHAZLARI**

REF.	BAĞLI AYDINLATMA KONTROL CİHAZLARI	AMB.	AD/€
<input type="checkbox"/> YW4001C <input type="checkbox"/> YG4001C <input type="checkbox"/> YD4001C	Bağlı Anahtar, 1M	1	80,00
<input type="checkbox"/> YW4003C <input type="checkbox"/> YG4003C <input type="checkbox"/> YD4003C	Bağlı Vavien Anahtar, 1M	1	80,00
<input type="checkbox"/> YW4006C <input type="checkbox"/> YG4006C <input type="checkbox"/> YD4006C	Bağlı Anahtar Nötrsüz, 1M	1	95,00
○ 3584C	Bağlı Aydınlatma Kontrol Rölesi	1	98,60
○ 412170	Aydınlatma için Bağlı DIN Rölesi, 1M DIN	1	149,01

**BAĞLI DİMMER/ANAHTAR**

REF.	BAĞLI DİMMER/ANAHTAR	AMB.	AD/€
<input type="checkbox"/> YW4411C <input type="checkbox"/> YG4411C <input type="checkbox"/> YD4411C	Bağlı Dimmer/Anahtar, 1M	1	93,00
<input type="checkbox"/> YW4412CM2 <input type="checkbox"/> YG4412CM2 <input type="checkbox"/> YD4412CM2	Bağlı Dimmer/Anahtar, 2M	1	134,00
<input type="checkbox"/> YW4413CM2 <input type="checkbox"/> YG4413CM2 <input type="checkbox"/> YD4413CM2	Bağlı Dimmer/Anahtar, Nötrsüz, 2M	1	140,00
○ 4411C	Bağlı Dimmer	1	154,61

**KABLOSUZ AYDINLATMA KONTROL CİHAZLARI**

REF.	KABLOSUZ AYDINLATMA KONTROL CİHAZLARI	AMB.	AD/€
<input type="checkbox"/> YW4003CWI <input type="checkbox"/> YG4003CWI <input type="checkbox"/> YD4003CWI	Kablosuz Aydınlatma Kontrol Cihazı, 1M	1	95,00
<input type="checkbox"/> YW4003CW <input type="checkbox"/> YG4003CW <input type="checkbox"/> YD4003CW	Kablosuz Aydınlatma Kontrol Cihazı, 2M	1	90,00
<input type="checkbox"/> YW4003DCW <input type="checkbox"/> YG4003DCW <input type="checkbox"/> YD4003DCW	Kablosuz İkili Aydınlatma Kontrol Cihazı, 2M	1	135,00
<input type="checkbox"/> YW4007CW <input type="checkbox"/> YG4007CW <input type="checkbox"/> YD4007CW	Kablosuz Zigbee Akıllı Ampul Kontrol Cihazı (Çok Renkli), 2M	1	85,00
<input type="checkbox"/> YW4007CWI <input type="checkbox"/> YG4007CWI <input type="checkbox"/> YD4007CWI	Kablosuz Zigbee Akıllı Ampul Kontrol Cihazı (Çok Renkli), 1M	1	85,00
<input type="checkbox"/> YW4003CWG <input type="checkbox"/> YG4003CWG <input type="checkbox"/> YD4003CWG	Kablosuz Pilsiz Aydınlatma Kontrol Cihazı, 2M	1	230,00
<input type="checkbox"/> YW4003CWDG <input type="checkbox"/> YG4003CWDG <input type="checkbox"/> YD4003CWDG	Kablosuz Pilsiz İkili Aydınlatma Kontrol Cihazı, 2M	1	260,00
○ 28003CWG	Kablosuz Pilsiz Aydınlatma Kontrol Cihazı IP55	1	230,00
○ 3577C	Mekanik Anahtarlar için Kablosuz Modül	1	118,76

**KABLOSUZ HAREKET SENSÖRÜ**

3585C

REF.	KABLOSUZ HAREKET SENSÖRÜ	AMB.	AD/€
○ 3585C	Kablosuz Hareket Sensörü	1	210,63

### BAĞLI PERDE/PANJUR KONTROL CİHAZLARI



REF.	BAĞLI PERDE/PANJUR KONTROL CİHAZLARI	AMB.	AD/€
<input type="checkbox"/> YW4027C <input type="checkbox"/> YG4027C <input type="checkbox"/> YD4027C	Bağlı Perde/Panjur Kontrol Cihazı, 1M	1	100,00
<input type="checkbox"/> YW4027CM2N <input type="checkbox"/> YG4027CM2N <input type="checkbox"/> YD4027CM2N	Bağlı Perde/Panjur Kontrol Cihazı, 2M	1	140,00
<input type="radio"/> 4027C	Bağlı Perde/Panjur Kontrol Modülü	1	182,62
<input type="radio"/> 3586C	Bağlı Garaj /Kapı Modülü	1	224,07

### KABLOSUZ PERDE/PANJUR KONTROL CİHAZLARI



REF.	KABLOSUZ PERDE/PANJUR KONTROL CİHAZLARI	AMB.	AD/€
<input type="checkbox"/> YW4027CWI <input type="checkbox"/> YG4027CWI <input type="checkbox"/> YD4027CWI	Kablosuz Perde/Panjur Kontrol Cihazı, 1M	1	90,00
<input type="checkbox"/> YW4027CW <input type="checkbox"/> YG4027CW <input type="checkbox"/> YD4027CW	Kablosuz Perde/Panjur Kontrol Cihazı, 2M	1	99,00
<input type="checkbox"/> YW4027CWG <input type="checkbox"/> YG4027CWG <input type="checkbox"/> YD4027CWG	Kablosuz Pilsiz Perde/Panjur Kontrol Cihazı, 2M	1	270,00
<input type="radio"/> 28027CWG	Kablosuz Pilsiz Perde Panjur Kontrol Cihazı IP55	1	260,00

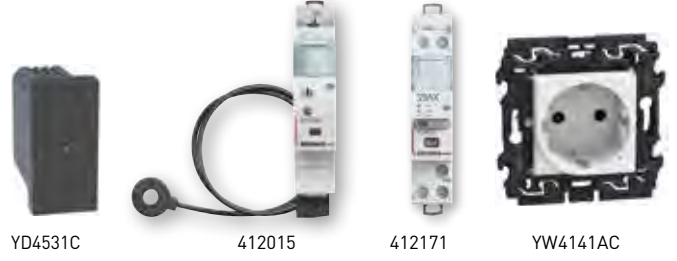

### BAĞLI ENERJİ YÖNETİMİ CİHAZLARI



REF.	BAĞLI ENERJİ YÖNETİMİ CİHAZLARI	AMB.	AD/€
<input type="checkbox"/> YW4531C <input type="checkbox"/> YG4531C <input type="checkbox"/> YD4531C	Bağlı Priz Modülü, 1M	1	120,00
<input type="checkbox"/> YW4141AC <input type="checkbox"/> YG4141AC <input type="checkbox"/> YD4141AC	Bağlı Alman Tipi Çocuk Korumalı Topraklı Priz, Monoblok, 2M	1	143,00
<input type="checkbox"/> YW4142AC <input type="checkbox"/> YG4142AC <input type="checkbox"/> YD4142AC	Bağlı Fransız Tipi Çocuk Korumalı Topraklı Priz, Monoblok, 2M	1	132,00
<input type="radio"/> 412171	Bağlı Kontaktör, 20A, 1M DIN	1	224,07
<input type="radio"/> 412015	Bağlı DIN Enerji Analizörü, 1M DIN	1	154,61
<input type="radio"/> 412173	Bağlı Kuru Kontak Modülü, 1M DIN	1	200,54

**AĞ GEÇİDİ MODÜLLERİ**

412181B

REF.	AĞ GEÇİDİ MODÜLLERİ	AMB.	AD/€
<input type="radio"/> 412181B	 Pano Tipi Ağ Geçidi Modülü, 2.5M DIN	1	200,00
<input type="checkbox"/> S36GWDC <input type="checkbox"/> S36GWGC	 Bağlı Tak Çalıştır Ağ Geçidi Modülü	1	190,46

**BAĞLI FİŞ/PRİZLER**

4141PC



4142PC



REF.	BAĞLI FİŞ/PRİZLER	AMB.	AD/€
<input type="radio"/> 4141PC	 Bağlı Alman Tipi Çocuk Korumalı Topraklı Fiş/Priz	1	163,57
<input type="radio"/> 4142PC	 Bağlı Fransız Tipi Çocuk Korumalı Topraklı Fiş/Priz	1	163,57

**BAĞLI TERMOSTATLAR**

XG8002



XW8002W

REF.	BAĞLI TERMOSTATLAR	AMB.	AD/€
<input type="checkbox"/> XW8002 <input type="checkbox"/> XG8002	 Smarter with Netatmo Termostat	1	445,90
<input type="checkbox"/> XW8002W	 Smarter with Netatmo Termostat, Sıva Üstü	1	445,90

KABLOSUZ SENARYO KONTROL CİHAZLARI











YW4570CW

YG4570CWG

YD4570CWI

3528C

REF.	KABLOSUZ SENARYO KONTROL CİHAZLARI	AMB.	AD/€
<input type="checkbox"/> YW4570CWI <input type="checkbox"/> YG4570CWI <input type="checkbox"/> YD4570CWI	 Kablosuz Giriş/Çıkış Senaryo Kontrol Cihazı, 1M	1	90,00
<input type="checkbox"/> YW4570CW <input type="checkbox"/> YG4570CW <input type="checkbox"/> YD4570CW	 Kablosuz Giriş/Çıkış Senaryo Kontrol Cihazı, 2M	1	94,00
<input type="checkbox"/> YW4570CWG <input type="checkbox"/> YG4570CWG <input type="checkbox"/> YD4570CWG	 Kablosuz Pilsiz Giriş/Çıkış Senaryo Kontrol Cihazı, 2M	1	290,00
<input type="checkbox"/> YW4574CWI <input type="checkbox"/> YG4574CWI <input type="checkbox"/> YD4574CWI	 Kablosuz Gece/Gündüz Senaryo Kontrol Cihazı, 1M	1	95,00
<input type="checkbox"/> YW4574CW <input type="checkbox"/> YG4574CW <input type="checkbox"/> YD4574CW	 Kablosuz Gece/Gündüz Senaryo Kontrol Cihazı, 2M	1	100,00
<input type="checkbox"/> YW4574CWG <input type="checkbox"/> YG4574CWG <input type="checkbox"/> YD4574CWG	 Kablosuz Pilsiz Gece/Gündüz Senaryo Kontrol Cihazı, 2M	1	290,00
<input type="checkbox"/> YW4575CW <input type="checkbox"/> YG4575CW <input type="checkbox"/> YD4575CW	 Kablosuz Dörtlü Senaryo Kontrol Cihazı, 2M	1	119,00
<input type="checkbox"/> YW4575CWG <input type="checkbox"/> YG4575CWG <input type="checkbox"/> YD4575CWG	 Kablosuz Pilsiz Dörtlü Senaryo Kontrol Cihazı, 2M	1	300,00
<input type="radio"/> 3528C	 Kablosuz Anahtarluk tipi Dörtlü Senaryo Kontrol Cihazı	1	164,69

Living Now <sup>WITH</sup> Netatmo

# AKILLI ELEKTRİK SİSTEMİ

Evinizi, e-mail hesabınızı ya da banka hesabınızı kontrol eder gibi kontrol edin. Tüm bu kontroller tamamen güvenli ve kolay kullanım ile parmağınızın ucunda.



HOME + CONTROL

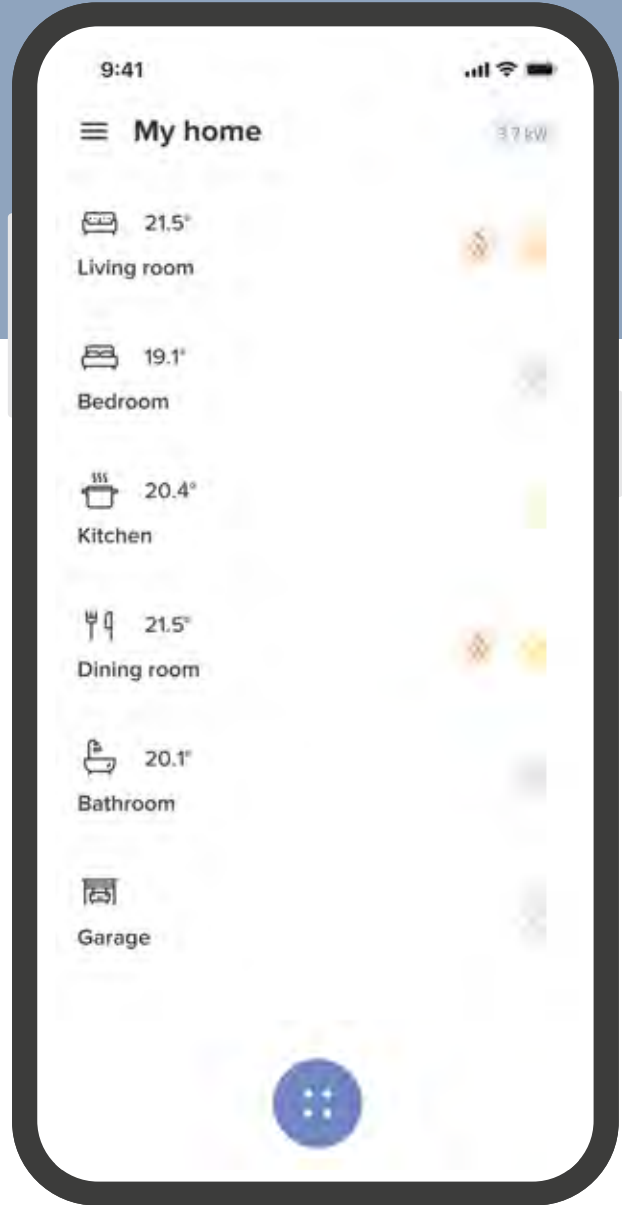

## GENEL KONTROL

Sadece tek bir tıkla evden çıkacağınız zaman tüm ışıkları kapatabilir ve panjurları indirebilirsiniz ya da isterseniz daha önceden belirlediğiniz senaryonuzu çalıştırabilirsiniz.



## AKILLI TELEFON İLE KONTROL

Akıllı telefonunuzdan nerede olursanız olun aydınlatma, perde-panjur, priz gibi cihazların durumlarını görebilir ya da kontrol edebilirsiniz.

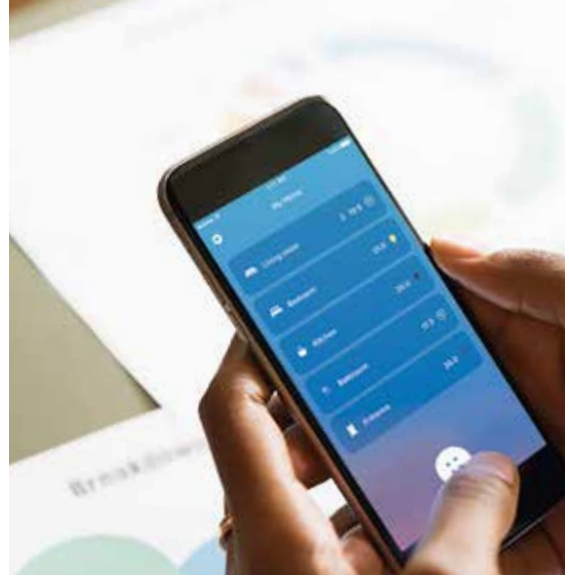

## SESLİ KOMUT

Sisteminizi sesli asistanız ile kontrol edebilirsiniz.

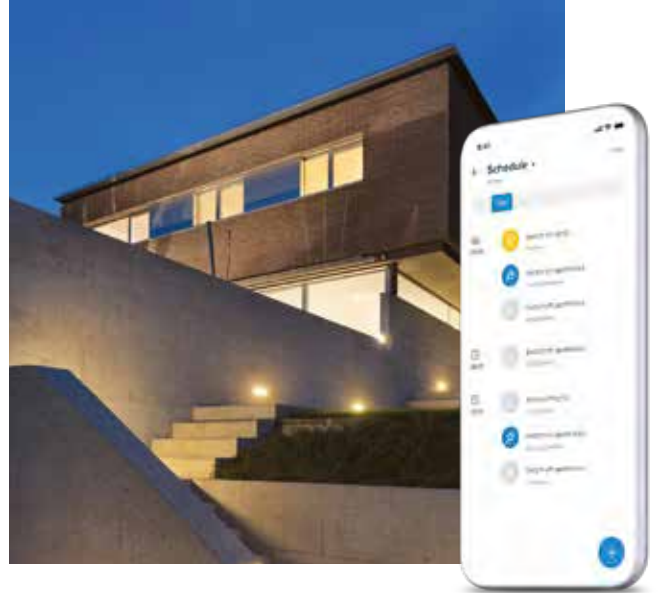







## PLANLANABİLİR PROGRAMLAR



İhtiyaçlarınıza göre aydınlatmaların, perde panjurların ve bağlı prizlere bağlı yüklerin aktivasyonunu programlayınız.

Örneğin:



- Gün batımında bahçe aydınlatmalarının otomatik olarak açılması, gün doğumunda kapanması
- Tatiliniz sırasında güvenliğinizi için evdeymiş gibi bazı aydınlatmaları ve perde/panjurları aktif edin

**BAĞLI AYDINLATMA KONTROL CİHAZLARI**

REF.	BAĞLI AYDINLATMA KONTROL CİHAZLARI	AMB.	AD/€	REF.	KAPAKLAR	AMB.	AD/€
○ K4001C	 Bağlı Anahtar, 1M	1	82,91	<input type="checkbox"/> KW01 <input checked="" type="checkbox"/> KG01 <input type="checkbox"/> KM01	 K4001C, K4003C ve K4411C için Kapak, 1M	20	3,86
○ K4003C	 Bağlı Vavien Anahtar, 1M	1	82,91	<input type="checkbox"/> KW01M2 <input checked="" type="checkbox"/> KG01M2 <input type="checkbox"/> KM01M2	 K4001C, K4003C ve K4411C için Kapak, 2M	10	6,21
○ K4006C	Bağlı Anahtar Nötrsüz, 1M	1	95,00	<input type="checkbox"/> KW33M2 <input checked="" type="checkbox"/> KG33M2 <input type="checkbox"/> KM33M2	 K4413CM2 için Kapak, 2M	20	6,72
○ 3584C	 Bağlı Aydınlatma Kontrol Rölesi	1	98,60				
○ 412170	 Aydınlatma için Bağlı DIN Rölesi, 1M DIN	1	149,01				













REF.	BAĞLI DİMMER/ANAHTAR	AMB.	AD/€
○ K4411C	 Bağlı Universal Dimmer/Anahtar, 1M	1	94,11
○ K4413CM2	 Bağlı Nötrsüz Dimmer/Anahtar, 2M	1	140,05
○ 4411C	 Bağlı Dimmer	1	154,61

\* Mekanizmalar aşağıdaki tabloda yer alan kapaklar ile tamamlanmalıdır.





REF.	KAPAK GÖRSELİ	KAPAK REFERANSLARI		
		BEYAZ	SİYAH	KUM BEJİ
K4001C		KW01/KW01M2	KG01/KG01M2	KM01/KM01M2
K4003C		KW01/KW01M2	KG01/KG01M2	KM01/KM01M2
K4006C				
K4411C		KW01/KW01M2	KG01/KG01M2	KM01/KM01M2
K4413CM2		KW33M2	KG33M2	KM33M2

## KABLOSUZ AYDINLATMA KONTROL CİHAZLARI



REF.	KABLOSUZ AYDINLATMA KONTROL CİHAZLARI	AMB.	AD/€	REF.	KAPAKLAR	AMB.	AD/€
○ K4003CWI	 Kablosuz Aydınlatma Kontrol Cihazı, 1M	1	112,04	<input type="checkbox"/> KW01 <input checked="" type="checkbox"/> KG01 <input type="checkbox"/> KM01	 K4003CWI için Kapak, 1M	20	3,86
○ K4007CWI	 Kablosuz Zigbee Akıllı Ampul Kontrol Cihazı (Çok Renkli), 1M	1	89,63	<input type="checkbox"/> KW42M2 <input checked="" type="checkbox"/> KG42M2 <input type="checkbox"/> KM42M2	 K4007CWI için Kapak, 2M	5	6,72
○ K4003CW	 Kablosuz Aydınlatma Kontrol Cihazı, 2M	1	101,96	<input type="checkbox"/> KW36M2 <input checked="" type="checkbox"/> KG36M2 <input type="checkbox"/> KM36M2	 K4003CW için Kapak, 1+1M	5	8,97
○ K4007CW	 Kablosuz Zigbee Akıllı Ampul Kontrol Cihazı (Çok Renkli), 2M	1	80,00	<input type="checkbox"/> KW39 <input checked="" type="checkbox"/> KG39 <input type="checkbox"/> KM39	 K4007CWI için Kapak, 1M	1	8,97
○ K4003DCW	 Kablosuz İkili Aydınlatma Kontrol Cihazı, 2M	1	151,25				
○ 3577C	 Mekanik Anahtarlar için Kablosuz Modül	1	118,76				
○ 28003CWG	 Kablosuz Pilsiz Aydınlatma Kontrol Cihazı IP55	1	230,00				
○ 3585C	 Kablosuz Hareket Sensörü	1	210,63				

\* Mekanizmalar aşağıdaki tabloda yer alan kapaklar ile tamamlanmalıdır.

REF.	KAPAK GÖRSELİ	KAPAK REFERANSLARI		
		BEYAZ	SİYAH	KUM BEJİ
K4003CWI		KW01	KG01	KM01
K4003CW		KW42M2	KG42M2	KM42M2
K4003DCW		KW36M2	KG36M2	KM36M2
K4007CWI		KW39	KG39	KM39

**BAĞLI PERDE/PANJUR KONTROL CİHAZLARI**

REF.	BAĞLI PERDE/PANJUR KONTROL CİHAZLARI	AMB.	AD/€	REF.	KAPAKLAR	AMB.	AD/€				
MEKANİZMA	<input type="radio"/> K4027C		Bağlı Perde/Panjur Kontrol Cihazı, 1M	1	114,27	<input type="checkbox"/> KW32 <input checked="" type="checkbox"/> KG32 <input type="checkbox"/> KM32		K4027C ve K4027CIL için Kapak, 1M	10	4,48	
	<input type="radio"/> K4027CIL		Bağlı Mekanik Kilitli Perde/Panjur Kontrol Cihazı, 1M	1	114,27		<input type="checkbox"/> KW32M2 <input checked="" type="checkbox"/> KG32M2 <input type="checkbox"/> KM32M2		K4027C, K4027CIL ve K4027CM2 için Kapak, 2M	10	6,72
	<input type="radio"/> K4027CM2N		Bağlı Perde/Panjur Kontrol Cihazı, 2M	1	151,25						
	<input type="radio"/> 4027C		Bağlı Perde/Panjur Kontrol Modülü	1	182,62						
	<input type="radio"/> 3586C		Bağlı Garaj /Kapı Modülü	1	224,07						

\* Mekanizmalar aşağıdaki tabloda yer alan kapaklar ile tamamlanmalıdır.

REF.	KAPAK GÖRSELİ	KAPAK REFERANSLARI			
		BEYAZ	SİYAH	KUM BEJİ	
SEÇİM TABLOSU	KAPAK SEÇİMİ		KW32/KW32M2	KG32/KG32M2	KM32/KM32M2
			KW32/KW32M2	KG32/KG32M2	KM32/KM32M2
			KW32M2	KW32M2	KW32M2

## KABLOSUZ PERDE/PANJUR KONTROL CİHAZLARI









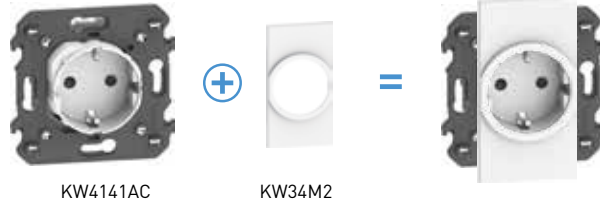

REF.	KABLOSUZ PERDE/PANJUR KONTROL CİHAZLARI	AMB.	AD/€	REF.	KAPAKLAR	AMB.	AD/€				
MEKANİZMA	<input type="radio"/> K4027CWI		Kablosuz Perde/Panjur Kontrol Cihazı, 1M	1	112,04	KAPAK	<input type="checkbox"/> KW32 <input checked="" type="checkbox"/> KG32 <input type="checkbox"/> KM32		K4027CWI için Kapak, 1M	10	4,48
	<input type="radio"/> K4027CW		Kablosuz Perde/Panjur Kontrol Cihazı, 2M	1	123,24		<input type="checkbox"/> KW43M2 <input checked="" type="checkbox"/> KG43M2 <input type="checkbox"/> KM43M2		K4027CW için Kapak, 2M	5	6,72
	<input type="radio"/> 28027CWG		Kablosuz Pilsiz Perde Panjur Kontrol Cihazı IP55	1	260,00						



\* Mekanizmalar aşağıdaki tabloda yer alan kapaklar ile tamamlanmalıdır.

REF.	KAPAK GÖRSELİ	KAPAK REFERANSLARI			
		BEYAZ	SİYAH	KUM BEJİ	
SEÇİM TABLOSU	KAPAK SEÇİMİ		KW32	KG32	KM32
			KW43M2	KG43M2	KM43M2



**BAĞLI ENERJİ YÖNETİMİ CİHAZLARI**

REF.	BAĞLI ENERJİ YÖNETİMİ CİHAZLARI	AMB.	AD/€	REF.	KAPAKLAR	AMB.	AD/€
○ K4531C	 Bağlı Priz Modülü, 1M	1	82,91	□ KW31 ■ KG31 □ KM31	 K4531C için Kapak, 1M	10	4,78
□ KW4141AC ■ KG4141AC □ KM4141AC	 Bağlı Alman Tipi Çocuk Korumalı Topraklı Priz, Monoblok, 2M	1	128,85	□ KW34M2 ■ KG34M2 □ KM34M2	 K*4141AC için Kapak, 2M	5	6,72
□ KW4142AC ■ KG4142AC □ KM4142AC	 Bağlı Fransız Tipi Çocuk Korumalı Topraklı Priz, Monoblok, 2M	1	128,85 118,76 118,76	□ KW35M2 ■ KG35M2 □ KM35M2	 K*4142AC için Kapak, 2M	5	6,72
○ 412171	 Bağlı Kontaktör, 20A, 1M DIN	1	224,07				
○ 412015	 Bağlı DIN Enerji Analizörü, 1M DIN	1	154,61				
○ 412173	 Bağlı Kuru Kontak Modülü, 1M DIN	1	200,54				

\* Mekanizmalar aşağıdaki tabloda yer alan kapaklar ile tamamlanmalıdır.

REF.	KAPAK GÖRSELİ	KAPAK REFERANSLARI		
		BEYAZ	SİYAH	KUM BEJİ
K4531C		KW31	KG31	KM31
KW4141AC KG4141AC KM4141AC		KW34M2	KG34M2	KM34M2
KW4142AC KG4142AC KM4142AC		KW35M2	KG35M2	KM35M2

**BAĞLI FİŞ/PRİZLER**

REF.	BAĞLI FİŞ/PRİZLER	AMB.	AD/€
■ 4141PC	 Bağlı Alman Tipi Çocuk Korumalı Topraklı Fiş/Priz	1	163,57
■ 4142PC	 Bağlı Fransız Tipi Çocuk Korumalı Topraklı Fiş/Priz	1	163,57

## PRİZLİ AĞ GEÇİDİ MODÜLÜ

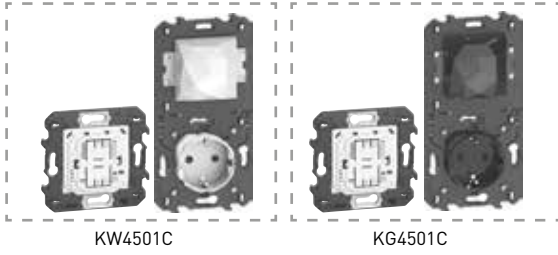

KW4501C

KG4501C



KM51



KW34M2



KG35M2







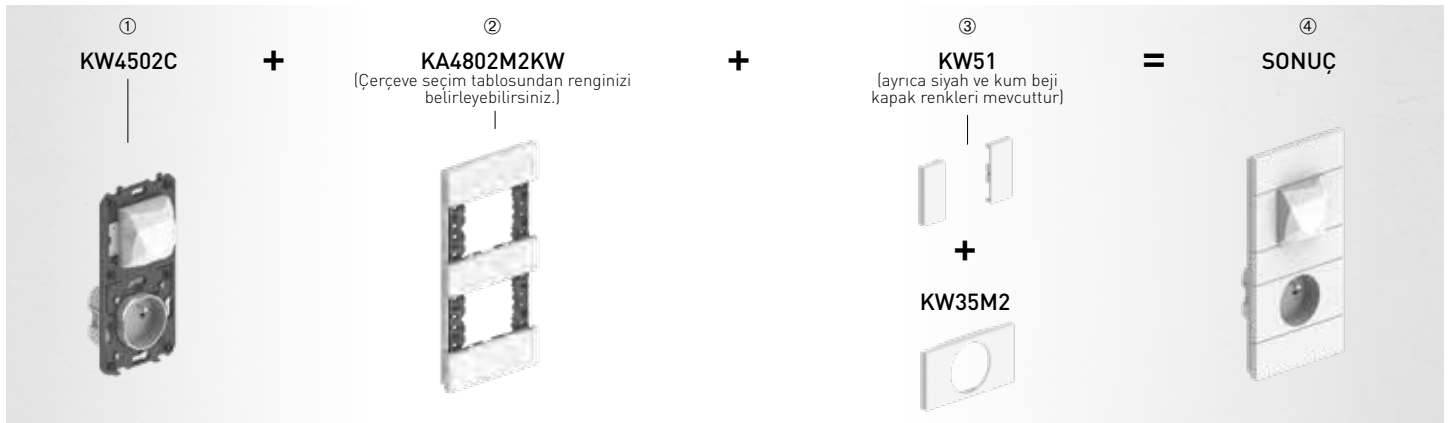

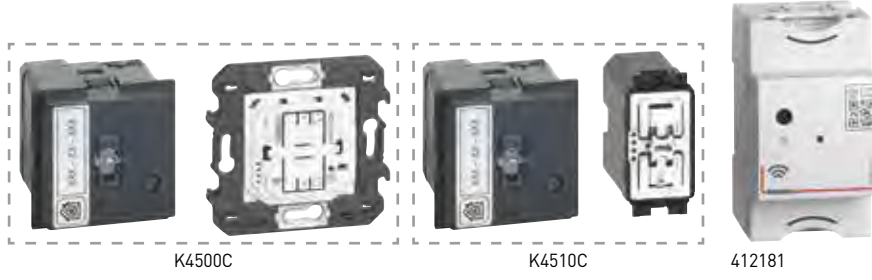
REF.	PRİZLİ AĞ GEÇİDİ MODÜLÜ	AMB. AD/€	REF.	KAPAKLAR	AMB. AD/€
<input type="checkbox"/> KW4501C <input checked="" type="checkbox"/> KG4501C <input type="checkbox"/> KM4501C	Ağ Geçidi Modülü + Alman Std. Çocuk Korumalı Topraklı Priz, 2+2M Kablosuz Giriş/Çıkış Senaryo Kontrol, 2M	1 320,42	<input type="checkbox"/> KW51 <input checked="" type="checkbox"/> KG51 <input type="checkbox"/> KM51	Ağ Geçidi Modülü için Kapak, 2M	10 6,07
<input type="checkbox"/> KW4502C <input checked="" type="checkbox"/> KG4502C <input type="checkbox"/> KM4502C	Ağ Geçidi Mod. + Fransız Std. Çocuk Korumalı Topraklı Priz, 2+2M Kablosuz Giriş/Çıkış Senaryo Kontrol, 2M	1 361,87	<input type="checkbox"/> KW34M2 <input checked="" type="checkbox"/> KG34M2 <input type="checkbox"/> KM34M2	K*4501C için Kapak, 2M	5 6,72
			<input type="checkbox"/> KW35M2 <input checked="" type="checkbox"/> KG35M2 <input type="checkbox"/> KM35M2	K*4502C için Kapak, 2M	5 6,72
			<input type="checkbox"/> KW40M2 <input checked="" type="checkbox"/> KG40M2 <input type="checkbox"/> KM40M2	K4570CW için Kapak, 2M	5 6,72

\* Mekanizmalar aşağıdaki tabloda yer alan kapaklar ile tamamlanmalıdır.

REF.	KAPAK GÖRSELİ	KAPAK REFERANSLARI		
		BEYAZ	SİYAH	KUM BEJİ
KW4501C		KW51+KW34M2+KW40M2		
KG4501C		KG51+KG34M2+KG40M2		
KM4501C		KM51+KM34M2+KM40M2		
KW4502C		KW51+KW35M2+KW40M2		
KG4502C		KG51+KG35M2+KG40M2		
KM4502C		KM51+KM35M2+KM40M2		



**AĞ GEÇİDİ MODÜLLERİ**

REF.	AĞ GEÇİDİ MODÜLLERİ	AMB.	AD/€	REF.	KAPAKLAR	AMB.	AD/€
<input type="radio"/> K4500C	 Ağ Geçidi Modülü, 2M + Kablosuz Giriş/Çıkış Senaryo Cihazı, 2M	1	271,12	<input type="checkbox"/> KW30M2 <input checked="" type="checkbox"/> KG30M2 <input type="checkbox"/> KM30M2	 Ağ Geçidi Modülü için Kapak, 2M	5	6,72
<input type="radio"/> K4510C	 Ağ Geçidi Modülü, 2M+ Kablosuz Giriş/Çıkış Senaryo Cihazı, 1M	1	276,73	<input type="checkbox"/> KW40 <input checked="" type="checkbox"/> KG40 <input type="checkbox"/> KM40	 K4570CWI için Kapak, 1M	10	4,48
<input type="radio"/> 412181B	 Pano Tipi Ağ Geçidi Modülü, 2.5M DIN	1	200,00	<input type="checkbox"/> KW40M2 <input checked="" type="checkbox"/> KG40M2 <input type="checkbox"/> KM40M2	 K4570CW için Kapak, 2M	5	6,72
<input checked="" type="checkbox"/> S36GWGC	 Bağlı Tak Çalıştır Ağ Geçidi Modülü	1	190,46				
<input type="checkbox"/> S36GWDC	 Bağlı Tak Çalıştır Ağ Geçidi Modülü	1	190,46				

\* Mekanizmalar aşağıdaki tabloda yer alan kapaklar ile tamamlanmalıdır.

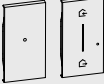
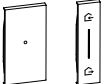

REF.	KAPAK GÖRSELİ	KAPAK REFERANSLARI		
		BEYAZ	SİYAH	KUM BEJİ
K4500C		KW30M2 + KW40M2	KG30M2 + KG40M2	KM30M2 + KM40M2
K4510C		KW30M2 + KW40	KG30M2 + KG40	KM30M2 + KM40

**BAĞLI TERMOSTATLAR**

XG8002



XW8002W











REF.	BAĞLI TERMOSTATLAR	AMB.	AD/€
<input type="checkbox"/> XW8002 <input checked="" type="checkbox"/> XG8002 <input type="checkbox"/> XM8002	 Smarter with Netatmo Termostat	1	445,90
<input type="checkbox"/> XW8002W	 Smarter with Netatmo Termostat, Sıva Üstü	1	445,90

## KABLOSUZ SENARYO KONTROL CİHAZLARI







K4574CWI

KW41

REF.	KABLOSUZ SENARYO KONTROL CİHAZLARI	AMB.	AD/€	REF.	KAPAKLAR	AMB.	AD/€
○ K4570CWI	 Kablosuz Giriş/Çıkış Senaryo Kontrol Cihazı, 1M	1	112,04	<input type="checkbox"/> KW40 <input checked="" type="checkbox"/> KG40 <input type="checkbox"/> KM40	 K4570CWI için Kapak, 1M	10	4,48
○ K4570CW	 Kablosuz Giriş/Çıkış Senaryo Kontrol Cihazı, 2M	1	112,04	<input type="checkbox"/> KW41 <input checked="" type="checkbox"/> KG41 <input type="checkbox"/> KM41	 K4570CW için Kapak, 1M	10	4,48
○ K4574CWI	 Kablosuz Gece/Gündüz Senaryo Kontrol Cihazı, 1M	1	112,04	<input type="checkbox"/> KW40M2 <input checked="" type="checkbox"/> KG40M2 <input type="checkbox"/> KM40M2	 K4574CWI için Kapak, 2M	5	6,72
○ K4574CW	 Kablosuz Gece/Gündüz Senaryo Kontrol Cihazı, 2M	1	123,24	<input type="checkbox"/> KW41M2 <input checked="" type="checkbox"/> KG41M2 <input type="checkbox"/> KM41M2	 K4574CW için Kapak, 2M	5	6,72
○ K4575CW	 Kablosuz Dörtlü Senaryo Kontrol Cihazı, 2M	1	137,80	<input type="checkbox"/> KW37M2 <input checked="" type="checkbox"/> KG37M2 <input type="checkbox"/> KM37M2	 K4575CW için Kapak, 1+1M	5	8,97
○ 3528C	 Kablosuz Anahtarlık tipi Dörtlü Senaryo Kontrol Cihazı	1	164,69				

\* Mekanizmalar aşağıdaki tabloda yer alan kapaklar ile tamamlanmalıdır.

REF.	KAPAK GÖRSELİ	KAPAK REFERANSLARI		
		BEYAZ	SİYAH	KUM BEJİ
K4570CWI		KW40	KG40	KM40
K4570CW		KW40M2	KG40M2	KM40M2
K4574CWI		KW41	KG41	KM41
K4574CW		KW41M2	KG41M2	KM41M2
K4575CW		KW37M2	KG37M2	KM37M2





**BAĞLI AYDINLATMA KONTROL CİHAZLARI**



L4003C 3584C 412170

REF.	BAĞLI AYDINLATMA KONTROL CİHAZLARI	AMB.	AD/€
<input type="checkbox"/> N4003C <input type="checkbox"/> NT4003C <input type="checkbox"/> L4003C	 Bağlı Vavien Anahtar, 1M	1	82,91
<input type="radio"/> 3584C	 Bağlı Aydınlatma Kontrol Rölesi	1	98,60
<input type="radio"/> 412170	 Aydınlatma için Bağlı DIN Rölesi, 1M DIN	1	149,01

**BAĞLI DİMMER/ANAHTAR**

L4411C 4411C N4413CM2

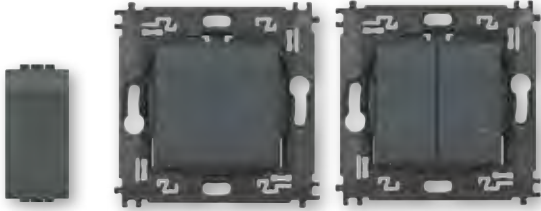
REF.	BAĞLI DİMMER/ANAHTAR	AMB.	AD/€
<input type="checkbox"/> N4411C <input type="checkbox"/> NT4411C <input type="checkbox"/> L4411C	 Bağlı Universal Dimmer/Anahtar, 1M	1	99,71
<input type="checkbox"/> N4412CM2 <input type="checkbox"/> NT4412CM2 <input type="checkbox"/> L4412CM2	 Bağlı Dimmer/Anahtar, 2M	1	134,44
<input type="checkbox"/> N4413CM2 <input type="checkbox"/> NT4413CM2 <input type="checkbox"/> L4413CM2	 Bağlı Dimmer/Anahtar, Nötrsüz, 2M	1	140,05
<input type="radio"/> 4411C	 Bağlı Dimmer	1	154,61

**KABLOSUZ AYDINLATMA KONTROL CİHAZLARI**

LN4003CWI L4003CW L4003DCW

REF.	KABLOSUZ AYDINLATMA KONTROL CİHAZLARI	AMB.	AD/€
<input type="radio"/> LN4003CWI (*)	 Kablosuz Aydınlatma Kontrol Cihazı, 1M	1	106,44
<input type="checkbox"/> N4003CW <input type="checkbox"/> NT4003CW <input type="checkbox"/> L4003CW	 Kablosuz Aydınlatma Kontrol Cihazı, 2M	1	90,75
<input type="checkbox"/> N4003DCW <input type="checkbox"/> NT4003DCW <input type="checkbox"/> L4003DCW	 Kablosuz İkili Aydınlatma Kontrol Cihazı, 2M	1	141,16
<input type="radio"/> 3577C	 Mekanik Anahtarlar için Kablosuz Modül	1	118,76

**KABLOSUZ HAREKET SENSÖRÜ**

3585C

REF.	KABLOSUZ HAREKET SENSÖRÜ	AMB.	AD/€
<input type="checkbox"/> 3585C	 Kablosuz Hareket Sensörü	1	210,63

(\*) Ürün ambalajında beyaz, alüminyum ve antrasit olmak üzere üç farklı tuş kapağı mevcuttur.

## BAĞLI PERDE/PANJUR KONTROL CİHAZLARI



L4027C

4027C

REF.	BAĞLI PERDE/PANJUR KONTROL CİHAZLARI	AMB.	AD/€
<input type="checkbox"/> N4027C <input type="checkbox"/> NT4027C <input type="checkbox"/> L4027C		1	106,44
<input type="checkbox"/> N4027CIL <input type="checkbox"/> NT4027CIL <input type="checkbox"/> L4027CIL		1	106,44
○ 4027C		1	182,62
○ 3586C		1	224,07

## PRİZLİ AĞ GEÇİDİ MODÜLÜ

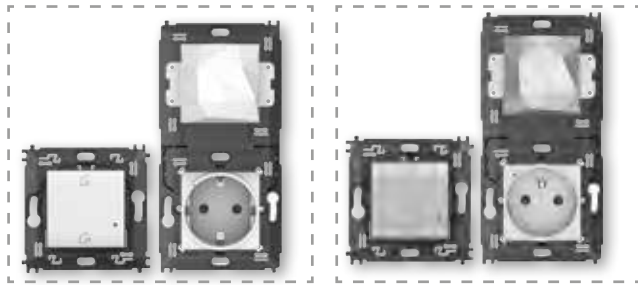

N4501C

NT4502C

REF.	PRİZLİ AĞ GEÇİDİ MODÜLÜ	AMB.	AD/€
<input type="checkbox"/> N4501C <input type="checkbox"/> NT4501C <input type="checkbox"/> L4501C		1	319,31 336,11 319,31
<input type="checkbox"/> N4502C <input type="checkbox"/> NT4502C <input type="checkbox"/> L4502C		1	360,75 380,92 315,93

## KABLOSUZ PERDE/PANJUR KONTROL CİHAZLARI

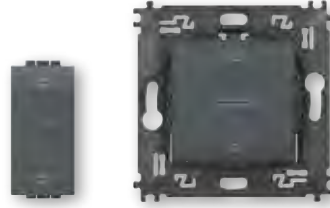

LN4027CWI

L4027CW

REF.	KABLOSUZ PERDE/PANJUR KONTROL CİHAZLARI	AMB.	AD/€
○ LN4027CWI (*)		1	99,71
<input type="checkbox"/> N4027CW <input type="checkbox"/> NT4027CW <input type="checkbox"/> L4027CW		1	112,04

(\*) Ürün ambalajında beyaz, alüminyum ve antrasit olmak üzere üç farklı tuş kapağı mevcuttur.

## BAĞLI ENERJİ YÖNETİMİ CİHAZLARI



L4531C

412015

412171

L4142AC

REF.	BAĞLI ENERJİ YÖNETİMİ CİHAZLARI	AMB.	AD/€
<input type="checkbox"/> N4531C <input type="checkbox"/> NT4531C <input type="checkbox"/> L4531C		1	82,91
<input type="checkbox"/> N4141AC <input type="checkbox"/> NT4141AC <input type="checkbox"/> L4141AC		1	128,85 126,60 127,72
<input type="checkbox"/> N4142AC <input type="checkbox"/> NT4142AC <input type="checkbox"/> L4142AC		1	147,88 151,25 147,88
○ 412171		1	224,07
○ 412015		1	154,61
○ 412173		1	200,54

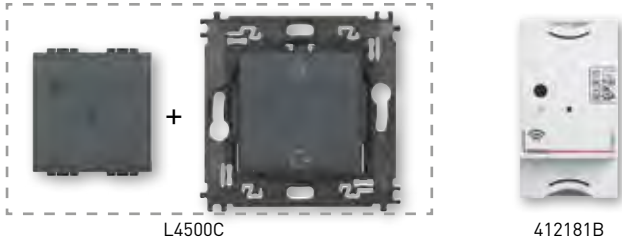
**AĞ GEÇİDİ MODÜLLERİ**

REF.	AĞ GEÇİDİ MODÜLLERİ	AMB.	AD/€
<input type="checkbox"/> N4500C <input type="checkbox"/> NT4500C <input type="checkbox"/> L4500C	Ağ Geçidi Modülü, 2M + Kablosuz Giriş/Çıkış Senaryo Cihazı, 2M	1	258,80
<input type="checkbox"/> N4510C <input type="checkbox"/> NT4510C <input type="checkbox"/> L4510C	Ağ Geçidi Modülü, 2M+ Kablosuz Giriş/Çıkış Senaryo Kontrol Cihazı, 1M	1	264,40
○ 412181B	Pano Tipi Ağ Geçidi Modülü, 2.5M DIN	1	200,00
<input type="checkbox"/> S36GWDC <input type="checkbox"/> S36GWGC	Bağlı Tak Çalıştır Ağ Geçidi Modülü	1	190,46

**BAĞLI TERMOSTATLAR**

REF.	BAĞLI TERMOSTATLAR	AMB.	AD/€
<input type="checkbox"/> XW8002 <input type="checkbox"/> XG8002	Smarter with Netatmo Termostat	1	445,90
○ XW8002W	Smarter with Netatmo Termostat, Sıva Üstü	1	445,90

**BAĞLI FİŞ/PRİZLER**

REF.	BAĞLI FİŞ/PRİZLER	AMB.	AD/€
○ 4141PC	Bağlı Alman Tipi Çocuk Korumalı Topraklı Fiş/Priz	1	163,57
○ 4142PC	Bağlı Fransız Tipi Çocuk Korumalı Topraklı Fiş/Priz	1	163,57

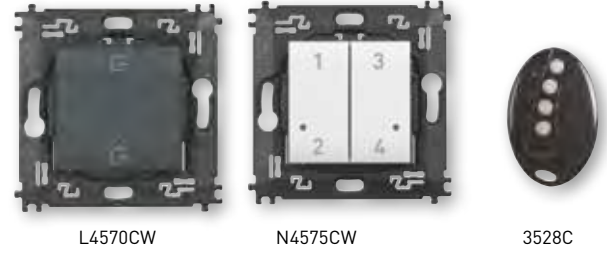
**KABLOSUZ SENARYO KONTROL CİHAZLARI**

REF.	KABLOSUZ SENARYO KONTROL CİHAZLARI	AMB.	AD/€
○ LN4570CWI (*)	Kablosuz Giriş/Çıkış Senaryo Kontrol Cihazı, 1M	1	96,35
<input type="checkbox"/> N4570CW <input type="checkbox"/> NT4570CW <input type="checkbox"/> L4570CW	Kablosuz Giriş/Çıkış Senaryo Kontrol Cihazı, 2M	1	104,19
○ LN4574CWI (*)	Kablosuz Gece/Gündüz Senaryo Kontrol Cihazı, 1M	1	96,35
<input type="checkbox"/> N4574CW <input type="checkbox"/> NT4574CW <input type="checkbox"/> L4574CW	Kablosuz Gece/Gündüz Senaryo Kontrol Cihazı, 2M	1	104,19
<input type="checkbox"/> N4575CW <input type="checkbox"/> NT4575CW <input type="checkbox"/> L4575CW	Kablosuz Dörtlü Senaryo Kontrol Cihazı, 2M	1	126,60
○ 3528C	Kablosuz Anahtarlık tipi Dörtlü Senaryo Kontrol Cihazı	1	164,69

(\*) Ürün ambalajında beyaz, alüminyum ve antrasit olmak üzere üç farklı tuş kapağı mevcuttur.

# HOME + CONTROL

Tek bir uygulama ile birden fazla cihazı kontrol edin.



Home+Control uygulaması ile Living Now akıllı elektrik sisteminizin tüm fonksiyonlarını iOS veya Android tabanlı mobil cihazlarınızdan evden veya dışardan kontrol edebilirsiniz.

Giriş sayfası tüm sistem bilgilerini göstermektedir.



## NELER YAPABİLİRSİNİZ?

1. 8 farklı senaryoyu (giriş, çıkış, gündüz, gece ve özelleştirilebilir 4 farklı senaryo) çalıştırabilir ve düzenleyebilirsiniz.
2. Aydınlatma, perde-panjur, prizlerin ve termostatların durumunu görüntüleyebilir veya kontrol edebilirsiniz.
3. Enerji tüketiminizi anlık olarak görüntüleyebilir, belirlediğiniz limit aşınca sürpriz faturalarla karşılaşmamak için uygulama üzerinden bildirimler alabilirsiniz.
4. Herhangi bir hata durumunda bildirimler alabilirsiniz.
5. Önceliklendirilmiş yük özelliği ile tüm sistemin enerjisinin kesilmesini önleyerek sadece ilgili yükün enerjisini otomatik olarak kesebilirsiniz.



**BAĞLI AYDINLATMA KONTROL CİHAZLARI**

REF.	BAĞLI AYDINLATMA KONTROL CİHAZLARI	AMB.	AD/€
<input type="checkbox"/> RW4003C <input checked="" type="checkbox"/> RG4003C	Bağlı Vavien Anahtar, 1M	1	79,55
<input type="radio"/> 3584C	Bağlı Aydınlatma Kontrol Rölesi	1	98,60
<input type="radio"/> 412170	Aydınlatma için Bağlı DIN Rölesi, 1M DIN	1	149,01

**BAĞLI DİMMER/ANAHTAR**

REF.	BAĞLI DİMMER/ANAHTAR	AMB.	AD/€
<input type="checkbox"/> RW4411C <input checked="" type="checkbox"/> RG4411C	Bağlı Universal Dimmer/Anahtar, 1M	1	91,86
<input type="checkbox"/> RW4412CM2 <input checked="" type="checkbox"/> RG4412CM2	Bağlı Dimmer/Anahtar, 2M	1	123,24
<input type="checkbox"/> RW4413CM2 <input checked="" type="checkbox"/> RG4413CM2	Bağlı Dimmer/Anahtar, Nötrsız, 2M	1	140,05
<input type="radio"/> 4411C	Bağlı Dimmer	1	154,61

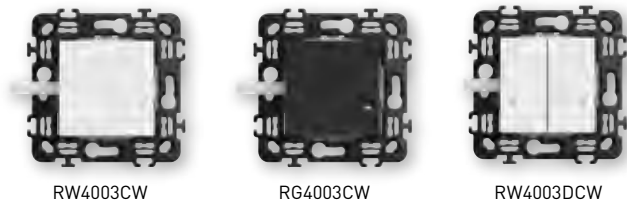
**KABLOSUZ AYDINLATMA KONTROL CİHAZLARI**

REF.	KABLOSUZ AYDINLATMA KONTROL CİHAZLARI	AMB.	AD/€
<input type="checkbox"/> RW4003CW <input checked="" type="checkbox"/> RG4003CW	Kablosuz Aydınlatma Kontrol Cihazı, 2M	1	84,03
<input type="checkbox"/> RW4003DCW <input checked="" type="checkbox"/> RG4003DCW	Kablosuz İkili Aydınlatma Kontrol Cihazı, 2M	1	135,57
<input type="radio"/> 3577C	Mekanik Anahtarlar için Kablosuz Modül	1	118,76

**KABLOSUZ HAREKET SENSÖRÜ**

REF.	KABLOSUZ HAREKET SENSÖRÜ	AMB.	AD/€
<input type="checkbox"/> 3585C	Kablosuz Hareket Sensörü	1	210,63

### BAĞLI PERDE/PANJUR KONTROL CİHAZLARI



RW4027C RG4027C RW4027CM2N RG4027CM2N

REF.	BAĞLI PERDE/PANJUR KONTROL CİHAZLARI	AMB.	AD/€
<input type="checkbox"/> RW4027C <input checked="" type="checkbox"/> RG4027C	Bağlı Perde/Panjur Kontrol Cihazı, 1M	1	99,71
<input type="checkbox"/> RW4027CM2N <input checked="" type="checkbox"/> RG4027CM2N	Bağlı Perde/Panjur Kontrol Cihazı, 2M	1	129,96
<input type="radio"/> 4027C	Bağlı Perde/Panjur Kontrol Modülü	1	182,62
<input type="radio"/> 3586C	Bağlı Garaj /Kapı Modülü	1	224,07

### BAĞLI ENERJİ YÖNETİMİ CİHAZLARI



RW4531C RG4531C 412171 RW4141AC

REF.	BAĞLI ENERJİ YÖNETİMİ CİHAZLARI	AMB.	AD/€
<input type="checkbox"/> RW4531C <input checked="" type="checkbox"/> RG4531C	Bağlı Priz Modülü, 1M	1	82,91
<input type="checkbox"/> RW4141AC <input checked="" type="checkbox"/> RG4141AC	Bağlı Alman Tipi Çocuk Korumalı Topraklı Priz, Monoblok, 2M	1	143,41
<input type="radio"/> 412171	Bağlı Kontaktör, 20A, 1M DIN	1	224,07
<input type="radio"/> 412015	Bağlı DIN Enerji Analizörü, 1M DIN	1	154,61
<input type="radio"/> 412173	Bağlı Kuru Kontak Modülü, 1M DIN	1	200,54

### KABLOSUZ PERDE/PANJUR KONTROL CİHAZLARI



RW4027CW RG4027CW

REF.	KABLOSUZ PERDE/PANJUR KONTROL CİHAZLARI	AMB.	AD/€
<input type="checkbox"/> RW4027CW <input checked="" type="checkbox"/> RG4027CW	Kablosuz Perde/Panjur Kontrol Cihazı, 2M	1	99,71

### PRİZLİ AĞ GEÇİDİ MODÜLÜ



RW4501C RG4501C

REF.	PRİZLİ AĞ GEÇİDİ MODÜLÜ	AMB.	AD/€
<input type="checkbox"/> RW4501C <input checked="" type="checkbox"/> RG4501C	Ağ Geçidi Modülü + Alman Std. Çocuk Korumalı Topraklı Priz, 2+2M Kablosuz Giriş/Çıkış Senaryo Kontrol, 2M	1	368,59 369,72

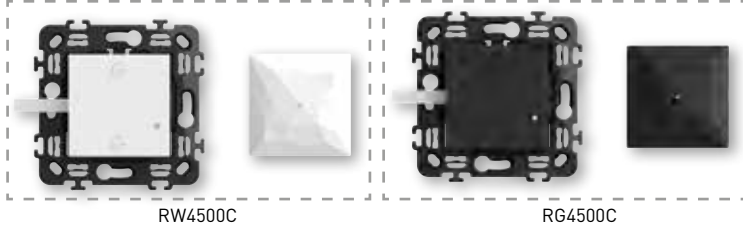
**AĞ GEÇİDİ MODÜLLERİ**

RW4500C

RG4500C

REF.	AĞ GEÇİDİ MODÜLLERİ	AMB.	AD/€
<input type="checkbox"/> RW4500C <input checked="" type="checkbox"/> RG4500C	Ağ Geçidi Modülü, 2M + Kablosuz Giriş/Çıkış Senaryo Cihazı, 2M	1	247,60
<input type="radio"/> 412181B	Pano Tipi Ağ Geçidi Modülü, 2.5M DIN	1	200,00
<input type="checkbox"/> S36GWDC <input checked="" type="checkbox"/> S36GWGC	Bağlı Tak Çalıştır Ağ Geçidi Modülü	1	190,46

**BAĞLI FİŞ/PRİZLER**

4141PC

4142PC

REF.	BAĞLI FİŞ/PRİZLER	AMB.	AD/€
<input type="radio"/> 4141PC	Bağlı Alman Tipi Çocuk Korumalı Topraklı Fiş/Priz	1	163,57
<input type="radio"/> 4142PC	Bağlı Fransız Tipi Çocuk Korumalı Topraklı Fiş/Priz	1	163,57

**BAĞLI TERMOSTATLAR**

XG8002

XW8002W

REF.	BAĞLI TERMOSTATLAR	AMB.	AD/€
<input type="checkbox"/> XW8002 <input checked="" type="checkbox"/> XG8002	Smarter with Netatmo Termostat	1	445,90
<input type="checkbox"/> XW8002W	Smarter with Netatmo Termostat, Sıva Üstü	1	445,90

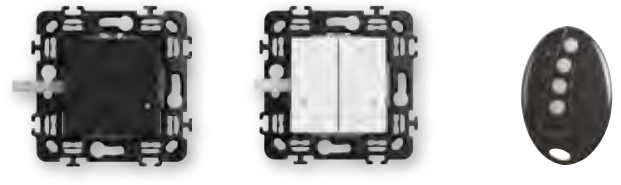
**KABLOSUZ SENARYO KONTROL CİHAZLARI**

RG4570CW

RW4575CW

3528C

REF.	KABLOSUZ SENARYO KONTROL CİHAZLARI	AMB.	AD/€
<input type="checkbox"/> RW4570CW <input checked="" type="checkbox"/> RG4570CW	Kablosuz Giriş/Çıkış Senaryo Kontrol Cihazı, 2M	1	97,47
<input type="checkbox"/> RW4574CW <input checked="" type="checkbox"/> RG4574CW	Kablosuz Gece/Gündüz Senaryo Kontrol Cihazı, 2M	1	97,47
<input type="checkbox"/> RW4575CW <input checked="" type="checkbox"/> RG4575CW	Kablosuz Dörtlü Senaryo Kontrol Cihazı, 2M	1	118,76
<input type="radio"/> 3528C	Kablosuz Anahtarlık tipi Dörtlü Senaryo Kontrol Cihazı	1	164,69



# Gelenekselden Akıllıya

- Sadece birkaç kablolama müdahalesi ile mevcut geleneksel sistemleri Akıllı sistemlere dönüştürmek için,
- Aydınlatmaların, perde-panjurların ve tüketim kontrolü içeren yeni Akıllı sistemler oluşturmak için,
- Çalışma alışkanlıklarınızı değiştirmeden kolayca kontrol için,

**İDEAL BİR ÇÖZÜMDÜR.**

## Classia

WITH

**Netatmo**

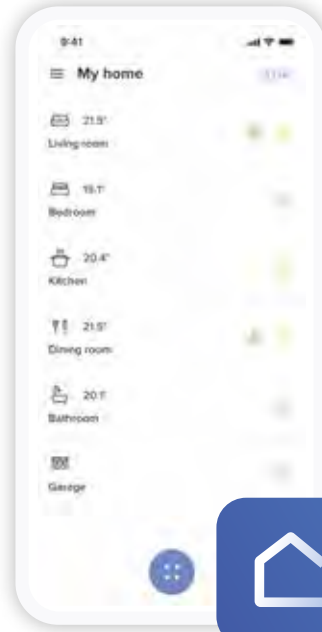

Home + Control



UZAKTAN  
KONTROL



SENARYO  
KONTROLÜ



SESLE  
KONTROL



PLANLANABİLİR  
PROGRAMLAR









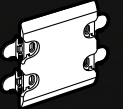
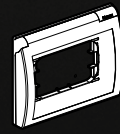
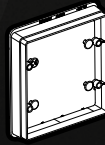
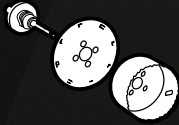
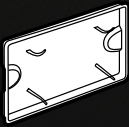
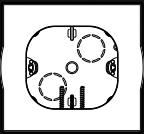

**bticino**



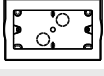





# KURULUM AKSESUARLARI



## BUATLAR

REF.	BUATLAR	AMB.	AD/€
○ 502E	Beton Duvar İçin Buat, 2M	50	2,940
○ 503E	Beton Duvar İçin Buat, 3M	15	3,110
○ 504E	Beton Duvar İçin Buat, 4M	5	3,310
○ 506E	Beton Duvar İçin Buat, 3+3M	2	4,540
○ 506L	Beton Duvar İçin Buat, 6/7M	1	5,180
○ 502W	Beton Duvar İçin Buat, AIR Serisi Kaide İçin, 2M	1	10,700
○ PB502NN	Alçıpan Duvar İçin Buat, 2M	5	3,670
○ PB503NN	Alçıpan Duvar İçin Buat, 3M	5	3,670
○ PB504NN	Alçıpan Duvar İçin Buat, 4M	5	5,530
○ PB506NN	Alçıpan Duvar İçin Buat, 6/7M	5	7,520
○ PB526NN	Alçıpan Duvar İçin Buat, 3+3M	5	7,520
○ PB502W	Alçıpan Duvar İçin Buat, AIR Serisi Kaide İçin, 2M	5	10,370
○ 502BI	 Sıva Üstü Kasa, 2M	1	13,160
○ 503BI	 Sıva Üstü Kasa, 3M	1	13,160
○ 504BI	 Sıva Üstü Kasa, 4M	1	15,050
○ 502LP	 Sıva Üstü Kasa, 2M	10	19,330
○ 503LP	 Sıva Üstü Kasa, 3M	10	19,330
○ 504LP	 Sıva Üstü Kasa, 4M	10	29,890

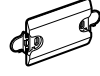
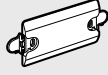
## KORUMA KILIFLARI VE AKSESUARLAR

REF.	KAİDE KORUMA KAPAKLARI	AMB.	AD/€
○ LN4782	 2M Kaideler İçin Koruma Kapağı	100	1,500
○ LN4783	 3M Kaideler İçin Koruma Kapağı	100	1,110
○ LN4784	 4M Kaideler İçin Koruma Kapağı	50	1,720
○ LN4787	 7M Kaideler İçin Koruma Kapağı	50	2,130
○ LN4786	 3+3M Kaideler İçin Koruma Kapağı	50	3,140
REF.	BUAT KORUMA KAPAKLARI	AMB.	AD/€
○ 503CG	 3M Modüler Buat (503E) İçin Koruma Kapağı	200	0,730
○ 503EV	 3M Modüler Buat (503E) İçin Bölücü Aparat	50	0,480
○ 503EC	 3M Modüler Buat (503E) İçin Kapak	1	2,210
○ 504EC	 4M Modüler Buat (504E) İçin Kapak	30	10,450
○ 506EC	 6M Modüler Buat (506E) İçin Kapak	1	16,480
○ 503ED	 2M (502E), 3M (503E), 4M (504E) Modüler Buatlar İçin Birleştirici Aparat	100	2,830

**IP KORUMALI BUATLAR VE ÇERÇEVELER - LIVING LIGHT**





REF.	IP40 IDROBOX S.Ü. BUATLAR	AMB.	AD/€
○ 24401	Idrobox Sıva Üstü Buat, IP40, 1M	1	10,170
○ 24402	Idrobox Sıva Üstü Buat, IP40, 2M	1	10,070
○ 24403	Idrobox Sıva Üstü Buat, IP40, 3M	1	13,400
○ 24404	Idrobox Sıva Üstü Buat, IP40, 4M	1	18,210
○ 24404/2	Idrobox Sıva Üstü Buat, IP40, 2+2M	1	13,400
○ 24406	Idrobox Sıva Üstü Buat, IP40, 6M	1	16,830

REF.	IP55 IDROBOX S.Ü. BUATLAR	AMB.	AD/€
○ 24501	Idrobox Sıva Üstü Buat, IP55, 1M	1	13,880
○ 24502	Idrobox Sıva Üstü Buat, IP55, 2M	1	13,880
○ 24503	Idrobox Sıva Üstü Buat, IP55, 3M	1	15,770
○ 24504	Idrobox Sıva Üstü Buat, IP55, 4M	1	26,100

**KURULUM AKSESUARLARI**

REF.	BUAT PLAKASI - AIR İÇİN	AMB.	AD/€
○ 503ESC	 AIR Çerçeve Kullanıldığında 3M Modüler Buat (503E) İçin Derinleştirici Aparat	5	5,200
○ 504ESC	 AIR Çerçeve Kullanıldığında 4M Modüler Buat (504E) İçin Derinleştirici Aparat	5	6,050
○ 506LSC	 AIR Çerçeve Kullanıldığında 6M Modüler Buat (503L) İçin Derinleştirici Aparat	3	10,010
○ 506ESC	 AIR Çerçeve Kullanıldığında 3+3M Modüler Buat (506E) İçin Derinleştirici Aparat	3	15,220

REF.	IP55 IDROBOX ÇERÇEVELER	AMB.	AD/€
■ 24602L	Idrobox Çerçeve, IP55, 2M	1	29,320
■ 24602N	Idrobox Çerçeve, IP55, 2M	1	20,310
■ 24602	Idrobox Çerçeve, IP55, 2M	1	20,310
■ 24603	Idrobox Çerçeve, IP55, 3M	1	22,550
■ 24603L	Idrobox Çerçeve, IP55, 3M	1	31,580
■ 24603N	Idrobox Çerçeve, IP55, 3M	1	22,550
■ 24604L	Idrobox Çerçeve, IP55, 4M	1	33,840
■ 24604N	Idrobox Çerçeve, IP55, 4M	1	27,070
■ 24604	Idrobox Çerçeve, IP55, 4M	1	27,070
○ 26603	 Idrobox Çerçeve, IP44, 3M	1	36,090

REF.	IP40 IDROBOX AKSESUARLARI	AMB.	AD/€
○ 25700	 Conta, IP55, Ø5-14-16-20 mm	10	0,490
○ 25700F/16	 Boru Contası, Ø16mm	10	20,160
○ 25700F/20	 Boru Contası, Ø20mm	10	23,600
○ 25701	 IP Korumalı Buatlar İçin Bölümleme Parçası, Yatay	10	2,520

○ 25701V	 IP Korumalı Buatlar İçin Bölümleme Parçası, Dikey	10	2,520
----------	--	----	-------

# Idrobox ÇERÇEVELER



IP44  
KORUMA KAPAK



**b**ticino

# TEKNİK ÇİZİMLER

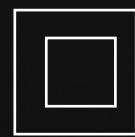
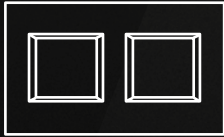
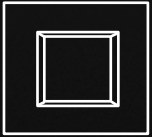

## CLASSIA by BTICINO ÇERÇEVELER

## Avrupa standardına uygun sistemler için (Geçmeli sistemler için)

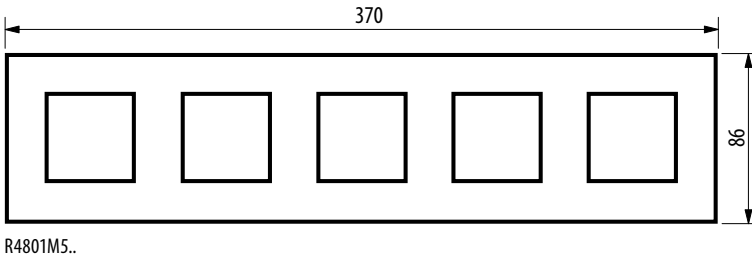
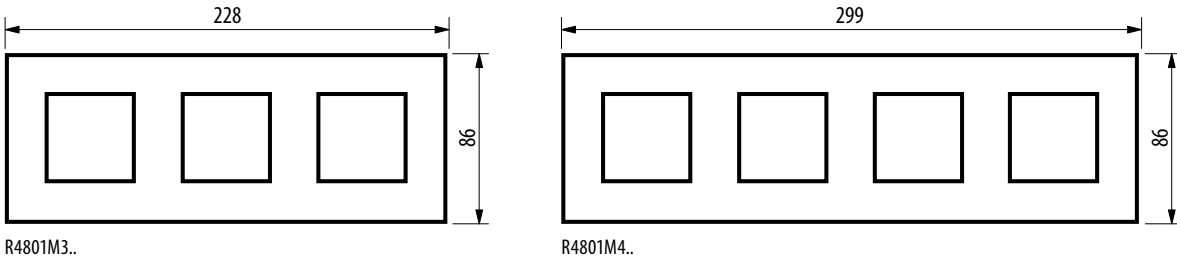
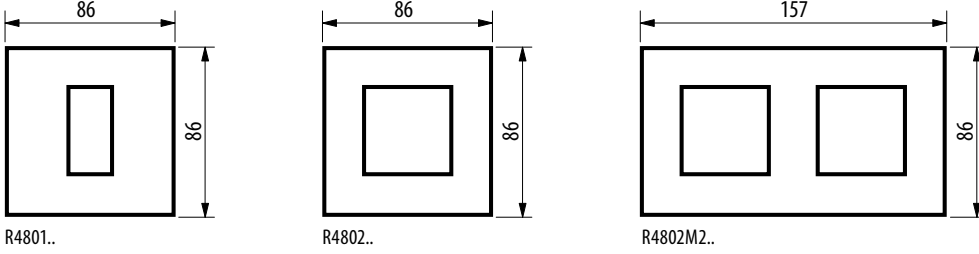

## İtalyan standardına uygun sistemler için (Modüler sistemler için)

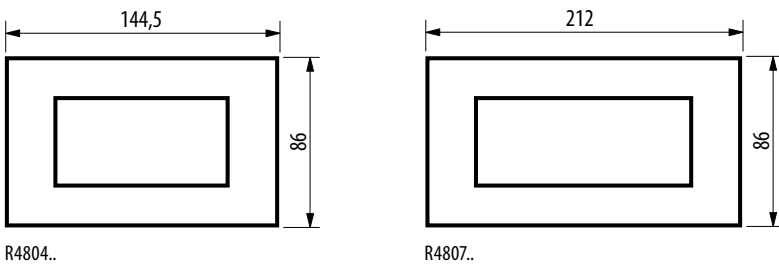
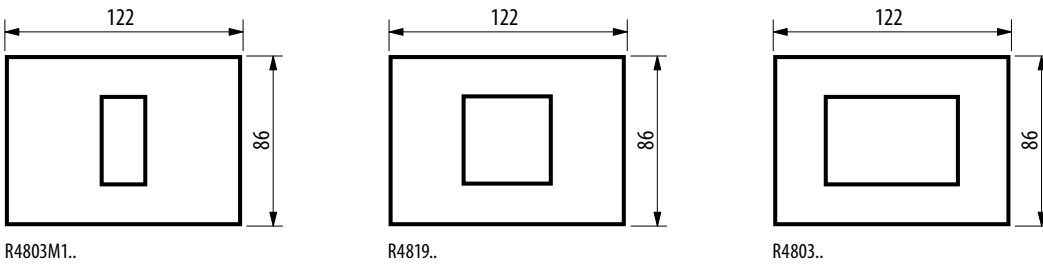

LIVINGLIGHT ÇERÇEVELER

Dikdörtgen çerçeveler

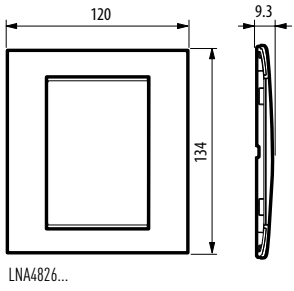
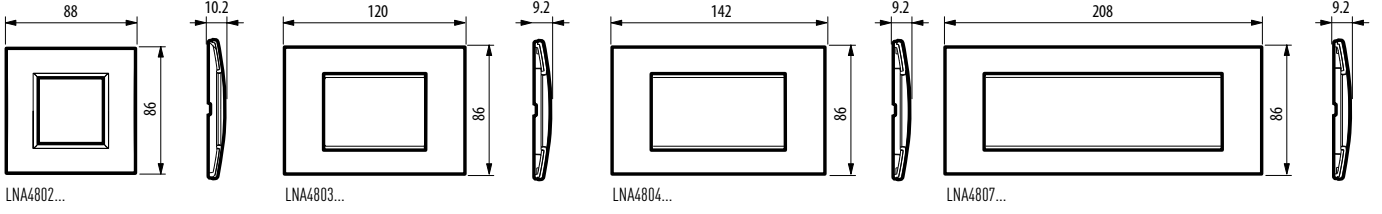

71 mm Merkez aralığı - Yatay/Dikey

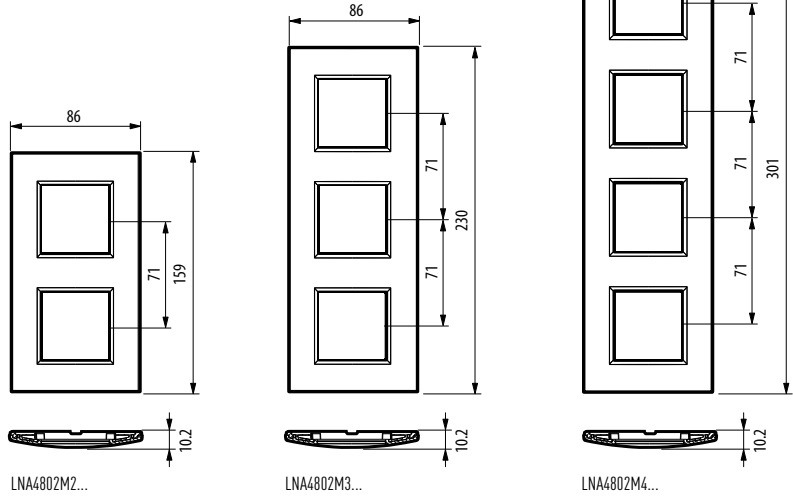

LIVINGLIGHT AIR çerçeveler (Modüler sistem)

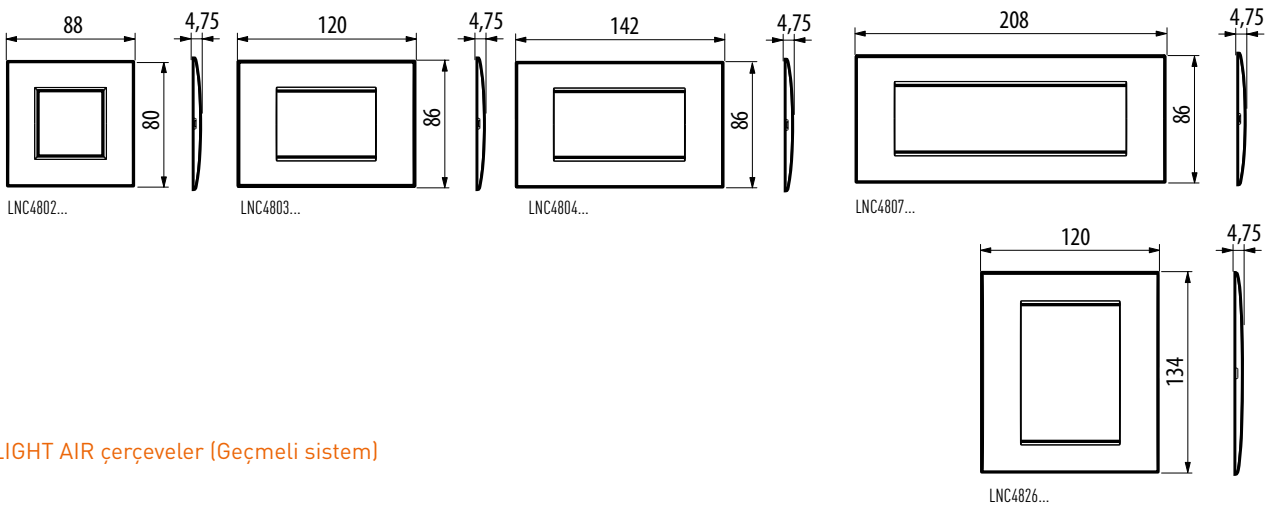

LIVINGLIGHT AIR çerçeveler (Geçmeli sistem)

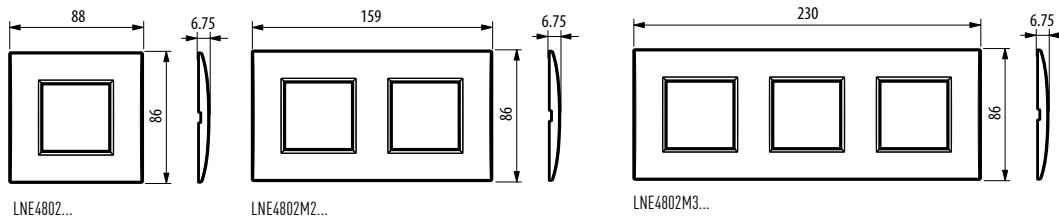

## LIVINGLIGHT ÇERÇEVELER

## Living international çerçeveler

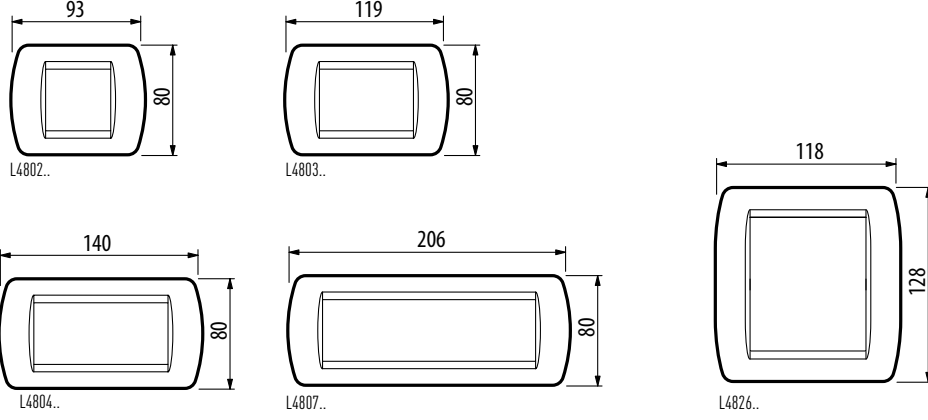

## LIVINGLIGHT BUATLAR

## Livinglight siva üstü buatlar

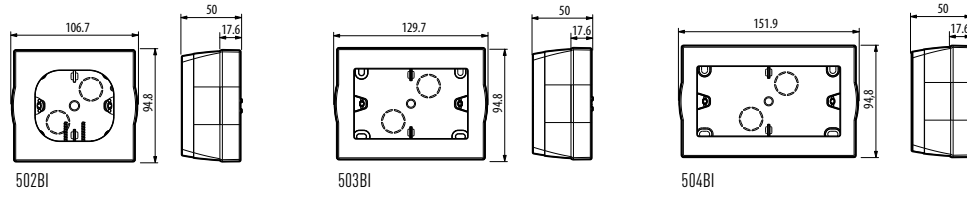

## Sıva altı buatlar (2 modül AIR çerçeveler için)

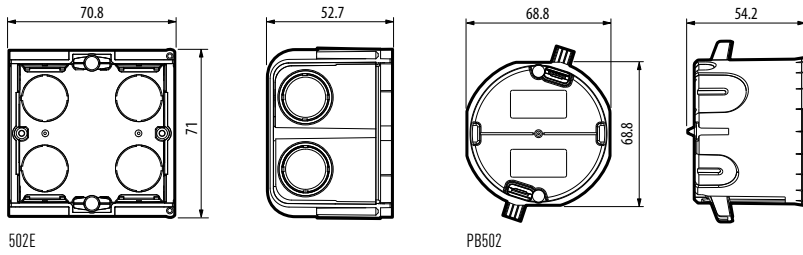

## Living international siva üstü buatlar

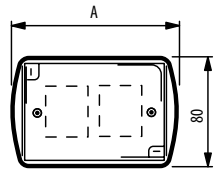

502LP  
503LP  
504LP

Item	A
502LP	93
503LP	120
504LP	140

LIVINGLIGHT KAİDELER

LIVINGLIGHT AIR KAİDELER  
MODÜLER SİSTEM

2 MODÜL KAİDE

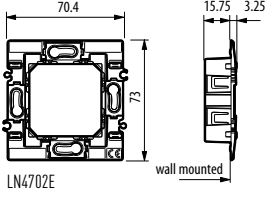

LN4702E

GEÇMELİ SİSTEM

2 MODÜL KAİDE

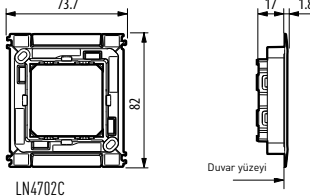

LN4702C

3 MODÜL KAİDE

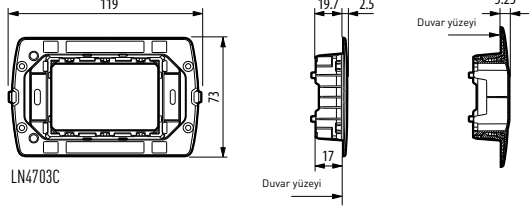

LN4703C

4 MODÜL KAİDE

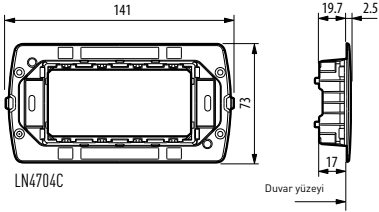

LN4704C

7 MODÜL KAİDE

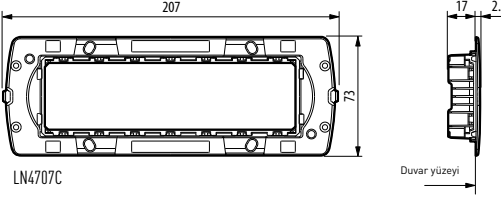

LN4707C

3+3 MODÜL KAİDE

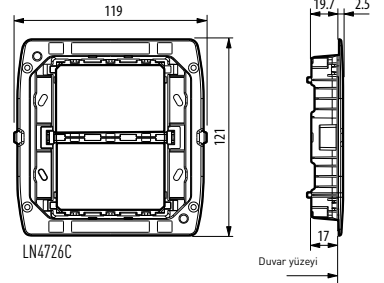

LN4726C

LIVINGLIGHT VE LIVING INTERNATIONAL KAİDELER

2 MODÜL KAİDE

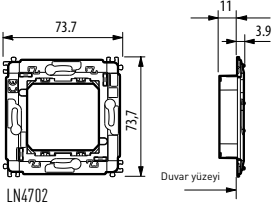

LN4702

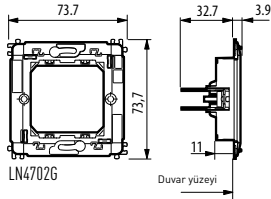

LN4702G

3 MODÜL KAİDE

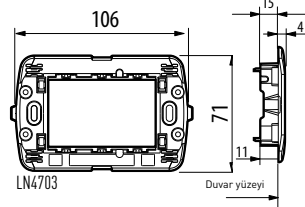

LN4703

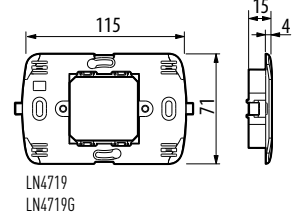

LN4719  
LN4719G

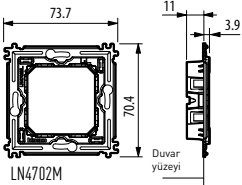

LN4702M

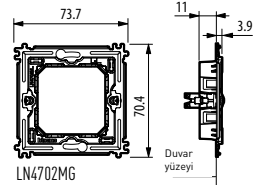

LN4702MG

4 MODÜL KAİDE

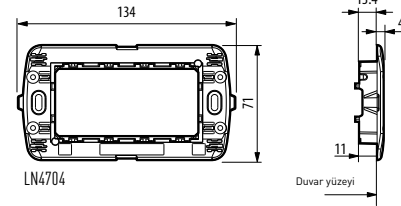

LN4704

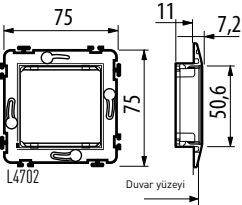

L4702

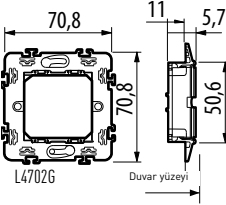

L4702G

3+3 MODÜL KAİDE

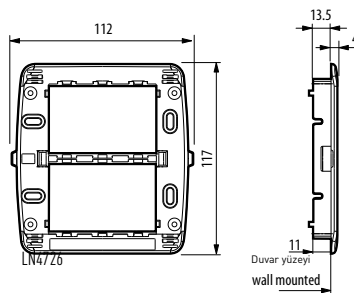

LN4726

7 MODÜL KAİDE

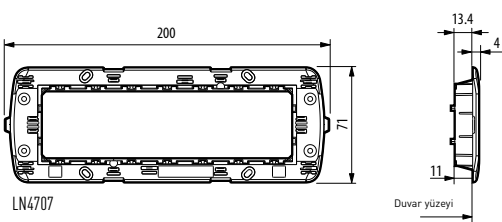

LN4707

## LIVING NOW ÇERÇEVELER (MODÜLER SİSTEM)

## LIVING NOW KAİDELER (MODÜLER SİSTEM)

## 2 MODÜL ÇERÇEVE

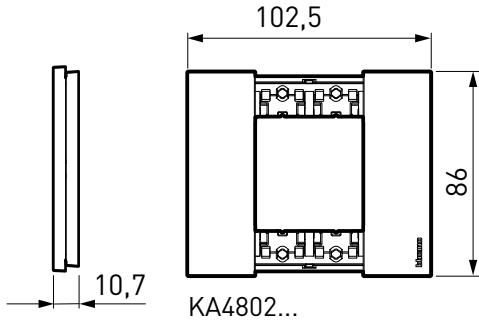

## 2 MODÜL KAİDE

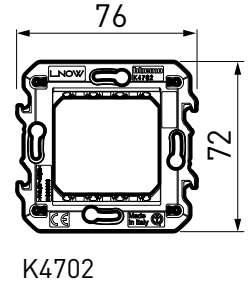

## 3 MODÜL ÇERÇEVE

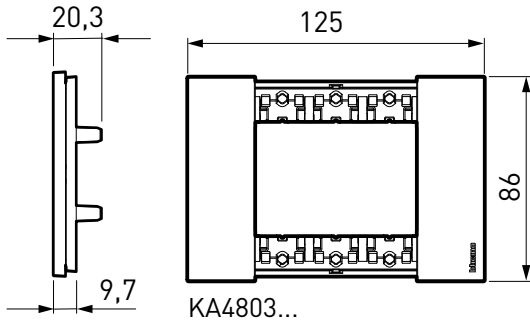

## 3 MODÜL KAİDE

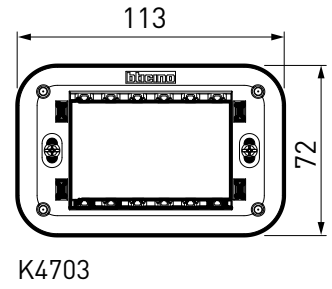

## 4 MODÜL ÇERÇEVE

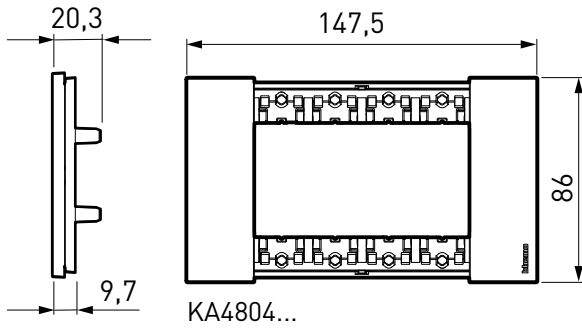

## 4 MODÜL KAİDE

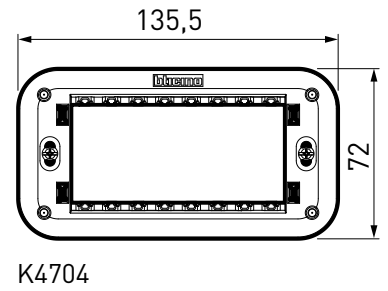

## 6 MODÜL ÇERÇEVE

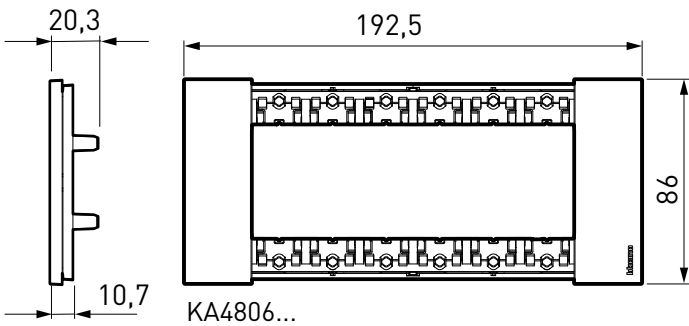

## 6 MODÜL KAİDE

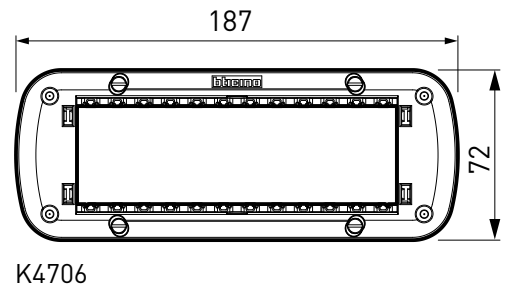

LIVING NOW ÇERÇEVELER (GEÇMELİ SİSTEM)

LIVING NOW KAİDELER (GEÇMELİ SİSTEM)

2 MODÜL ÇERÇEVE

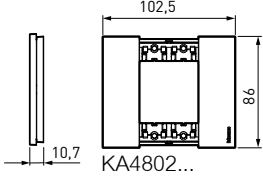

2 MODÜL KAİDE

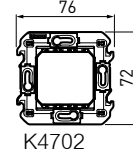

2+2 MODÜL ÇERÇEVE

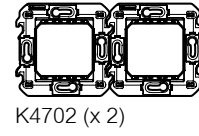
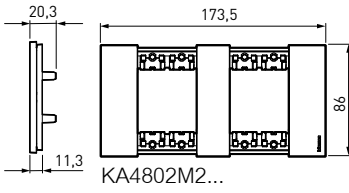

2+2+2 MODÜL ÇERÇEVE

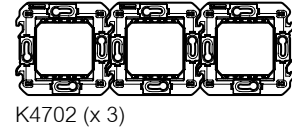
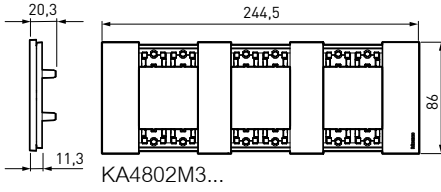

2+2+2+2 MODÜL ÇERÇEVE

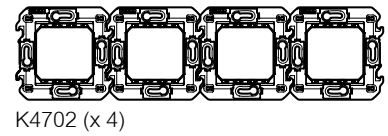
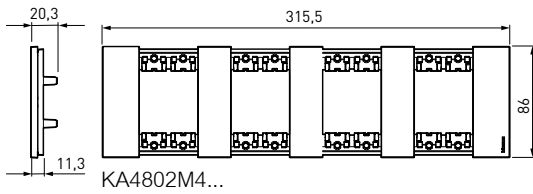

## LIGHT NOW ÇERÇEVELER (MODÜLER SİSTEM)

2 modül çerçeve

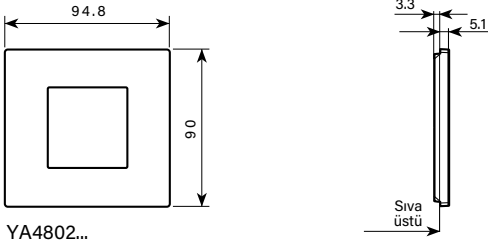

YA4802...

3 modül ortalanmış çerçeve

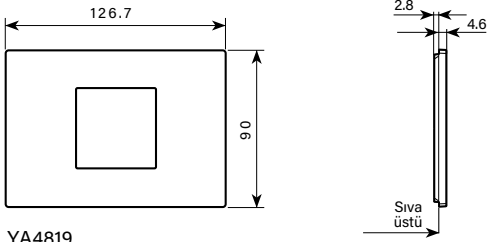

YA4819...

3 modül çerçeve

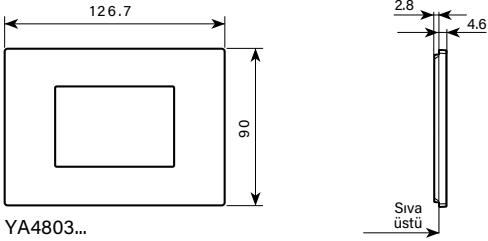

YA4803...

4 modül çerçeve

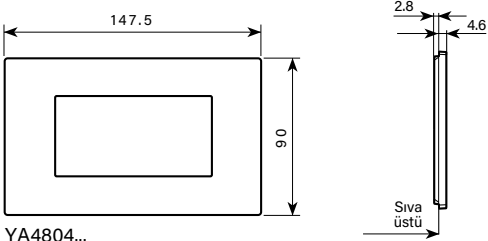

YA4804...

7 modül çerçeve

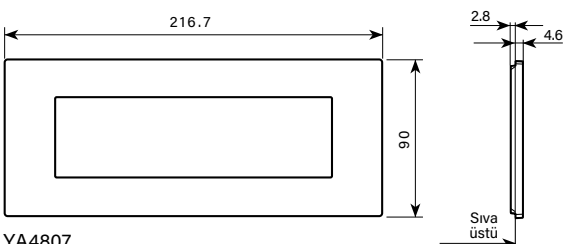

YA4807...

## LIGHT NOW KAİDELER (MODÜLER SİSTEM)

2 modül kaide

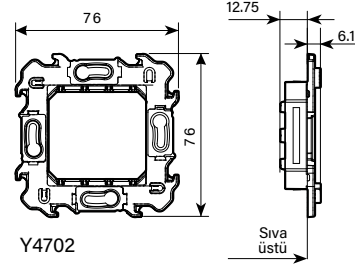

Y4702

2 modül ortalanmış kaide

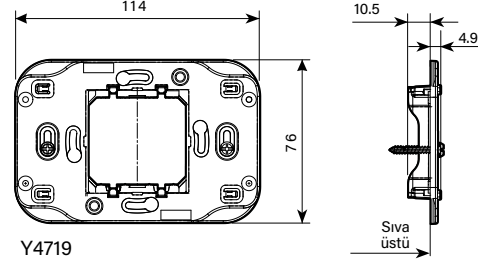

Y4719

3 modül kaide

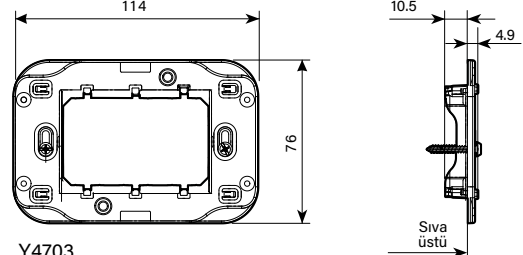

Y4703

4 modül kaide

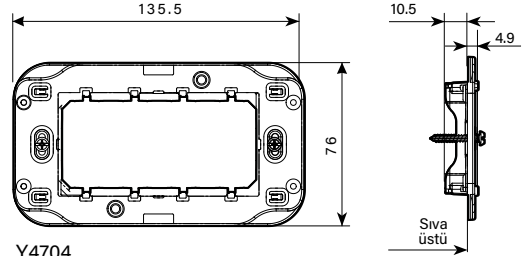

Y4704

7 modül kaide

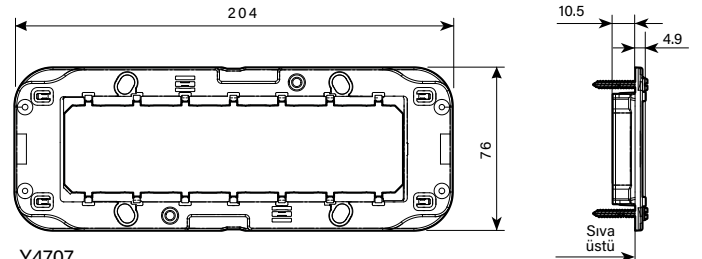

Y4707

LIGHT NOW ÇERÇEVELER (GEÇMELİ SİSTEM)

LIGHT NOW KAİDELER (GEÇMELİ SİSTEM)

2 modül çerçeve

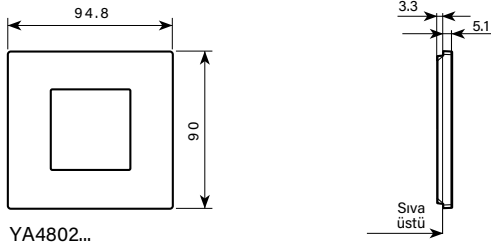

YA4802...

2 modül kaide

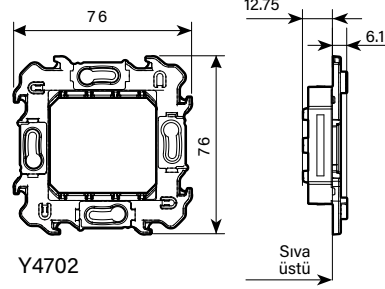

Y4702

2+2 modül çerçeve, 71 mm merkez aralığı - yatay/dikey kullanım

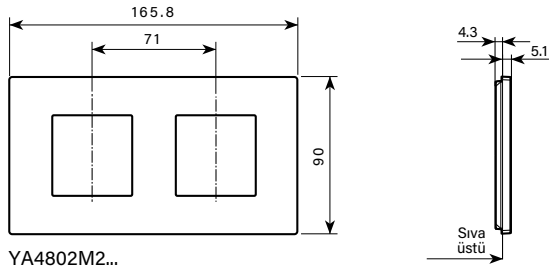

YA4802M2...

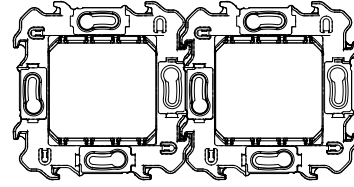

Y4702x2

2+2+2 modül çerçeve, 71 mm merkez aralığı - yatay/dikey kullanım

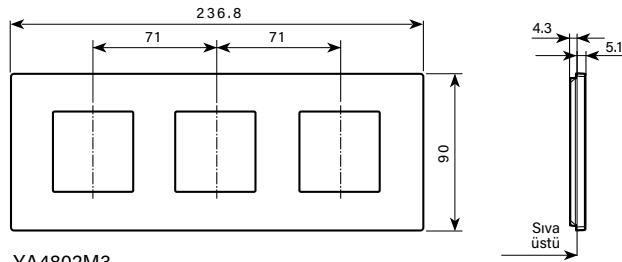

YA4802M3...

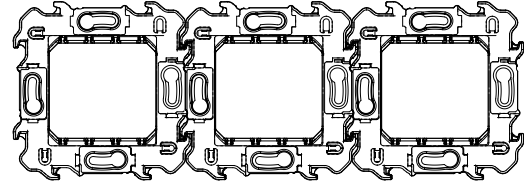

Y4702x3

2+2+2+2 modül çerçeve, 71 mm merkez aralığı - yatay/dikey kullanım

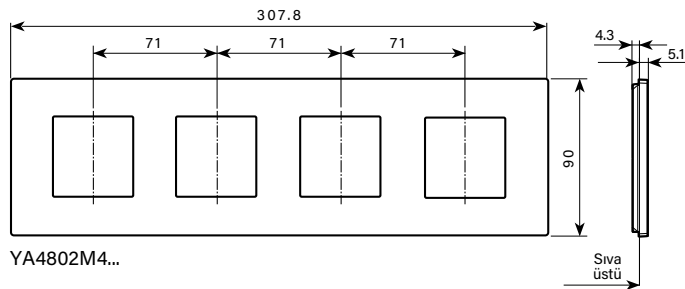

YA4802M4...

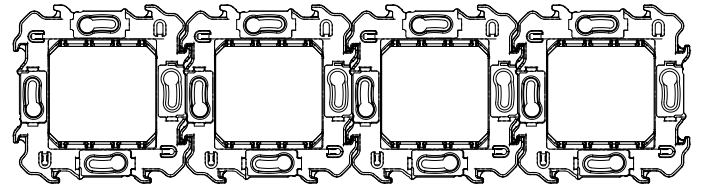

Y4702x4

# Bticino 2026 Satış Şartları

## SİPARİŞLER

- Komple ambalaj şeklindedir.
- Malın teslim tarihinden itibaren 4 gün içinde yapılmayan itirazlar dikkate alınmaz.
- Siparişlere, teslim anında yürürlükte olan sirküler ve fiyatlar uygulanır.
- Siparişler doğrudan toptancının fatura adresi veya deposuna sevk edilir.

## SATIŞ İSKONTO

- 2026 yılı satış şartları geçerlidir.
- Daha fazla bilgi için satış ofislerimize danışınız.

## ÖDEMELER

### Ödeme Süresi:

- Fiyatlarımız teslim adresi esasına göre tespit edilmiş olup, KDV dahil değildir.
- Ödemelerde fatura tarihi esas alınır.
- Son fatura tutarı 21 gün içinde ödenmeden yeni verilen siparişler işleme konmaz ve herhangi bir teslimat yapılmaz.

### Ödeme Şekli:

- Ödeme şekli konusunda satış bölümünün mutabakatı gereklidir.

## NAKİT İSKONTOSU

- Fatura tarihi ile ödeme tarihi arasında kalan zamana bağlı olarak tespit edilen nakit iskonto oranı 2026 yılı satış şartlarında veya daha sonra yayınlanmış duyurularda belirlenmiştir.





## SATIŞ İADELERİ

- Satış direktörünün onayı gerekmektedir.
- Navlun masrafı müşteriye aittir.

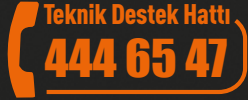
Legrand Elektrik San. A.Ş. önceden haber vermeksizin katalog ve fiyat listesinde bulunan ürünlerin teknik özelliklerinde ve fiyatlarında değişiklik yapma, satıştan çekme hakkını saklı tutar.

Genel Müdürlük  
Esenşehir Mah. Hale Sk. No:6/1 34776 Ümraniye - İstanbul  
Tel : (212) 368 28 00 (pbx)  
: (212) 251 34 30  
Faks : (216) 621 66 29  
: (216) 622 55 50  
e-posta : info.turkiye@legrand.com.tr



-  www.bticino.com.tr
-  linkedin.com/company/bticinoturkiye
-  instagram.com/bticino\_turkiye
-  facebook.com/BticinoTurkey

#### Bölge Müdürlükleri

##### Genel Müdürlük

Esenşehir Mah. Hale Sk. No:6/1  
34776 Ümraniye - İSTANBUL  
Tel : (212) 368 28 00 (pbx)  
: (212) 251 34 30  
Faks : (216) 621 66 29  
: (216) 622 55 50

##### Ankara Bölge Müdürlüğü

Timko İşyerleri Sitesi, Çamlıca  
Mahallesi Anadolu Bulvarı No:  
20/A-11 Merkez  
06560 Yenimahalle - ANKARA  
Tel : (312) 310 92 14  
: (312) 310 82 15  
Faks : (312) 312 28 88

##### Adana irtibat

GSM : (533) 968 16 91

##### Bursa Bölge Müdürlüğü

Üçevler mah. Bayraktepe sok.  
Akay İş Merkezi No: 7 D: 5  
16120 Nilüfer - BURSA  
Tel : (224) 443 28 00  
Faks : (224) 443 01 05

##### Antalya irtibat

Tel : (232) 469 23 33  
GSM : (549) 748 83 54  
Faks : (232) 469 26 66

##### Ege Bölge Müdürlüğü

1203/11 sokak No:5-7 Megapol  
Çarşı Kule, K:14 D:149  
Halkapınar Mah.  
35170 Konak/ İzmir  
Tel : (232) 469 23 33  
Faks : (232) 469 26 66

##### Eskişehir irtibat

GSM : (549) 748 88 05

##### Diyarbakır irtibat

GSM : (533) 968 16 79

##### Trabzon- Samsun irtibat

GSM : (549) 748 83 73

